



# OMNI-Test Laboratories, Inc.

EPA Standard of Performance for New Residential Wood Heaters

## Certification Test Report

### Non-Confidential Business Information (Non-CBI)

**Manufacturer:** Hearth & Home Technologies, Inc.  
**Heater Type:** Pellet-Fired, Freestanding  
**Model:** PS35-C

**Prepared for:** Hearth & Home Technologies, Inc.  
352 Mountain House Rd.  
Halifax, PA 17032  
USA

**Prepared by:** OMNI-Test Laboratories, Inc.  
13327 NE Airport Way  
Portland, OR 97230  
(503) 643-3788

**Test Period:** February 28, 2019

**Report Date:** April 12, 2019

**Report Number:** 0061PS086E

***All data and information contained in this report are confidential and proprietary to Hearth & Home Technologies. Its significance is subject to the adequacy and representative character of the samples and to the comprehensiveness of the tests, examinations, or surveys made. The contents of this report cannot be copied or quoted, except in full, without specific, written authorization from Hearth & Home Technologies and OMNI-Test Laboratories, Inc. No use of the OMNI-Test Laboratories, Inc. name, logo, or registered mark (O-TL) is permitted, except as expressly authorized by OMNI-Test Laboratories, Inc. in writing.***

## **AUTHORIZED SIGNATORIES**

This report has been reviewed and approved by the following authorized signatories:

### **Evaluator:**

  
\_\_\_\_\_  
Bruce Davis  
Technician  
OMNI-Test Laboratories, Inc.

### **Reviewer:**

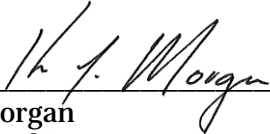
  
\_\_\_\_\_  
Ken Morgan  
Technical Services Director  
OMNI-Test Laboratories, Inc.

## TABLE OF CONTENTS

PREFACE .....	(3 pages)
<b>Section 1 –Appliance, Testing, &amp; Results .....</b>	<b>4</b>
1.1 Summary Tables .....	5
Table 1 – Particulate Emissions .....	5
Table 2 – Efficiency and CO.....	5
Table 3 – Test Facility Conditions .....	6
Table 4 – Heater Configuration .....	6
1.2 Procedures & Results Summary.....	7
1.3 Appliance Description .....	8
<b>Section 2 – Test Data .....</b>	<b>11</b>
2.1 Test Data by Run .....	13
2.2 Sample Analysis & Tares.....	41
<b>Section 3 –Laboratory Quality Assurance .....</b>	<b>49</b>
3.1 Quality Assurance/Quality Control.....	50
3.2 Calibration Data.....	51
3.3 Example Calculations .....	67
<b>Appendix A – Labeling &amp; Owner’s Manual</b>	

# **Section 1**

## **Appliance, Testing, & Results**

- 1.1 - Summary Tables
- 1.2 – Procedures and Results Summary
- 1.3 - Appliance Description

## 1.1 - Summary Tables

**Table 1 – Particulate Emissions**

	One-Hour Filter	Integrated Total
Emission Rate (g/hr)	2.04	1.02
Emission Factor (g/dry kg)	0.92	0.96

**Table 2 – Efficiency and CO**

	Burn Rate Segment			Integrated Total
	Maximum	Medium	Minimum	
Time (minutes)	61	121	180	362
Burn Rate (dry kg/hr)	2.232	1.040	0.671	1.057
Heat Input Rate (BTU/hr, HHV)	41,931	19,543	12,601	19,864
Heat Output Rate (BTU/hr, HHV)	29,680	12,938	8,649	13,667
Efficiency (% , HHV)	70.8%	66.2%	68.6%	68.8%
Efficiency (% , LHV)	75.7%	70.8%	73.4%	73.6%
CO Emission Rate (g/min)	0.04	0.15	0.17	0.15

## 1.1 - Summary Tables

**Table 3 – Test Facility Conditions**

	Initial	Middle	Final
Room Temperature (°F)	74	78	76
Barometric Pressure (in Hg)	30.26	30.20	30.14
Air Velocity (ft/min)	<50	<50	<50
Induced Draft (in H <sub>2</sub> O)	∅	∅	∅

**Table 4 – Heater Configuration**

	Pretest	Burn Rate Segment		
		Maximum	Medium	Minimum
Run 1	Heat: High FRAP: Full Open Control Trim: 3	Heat: High FRAP: Full Open Control Trim: 3	Heat: Med FRAP: Full Closed Control Trim: 2	Heat: Low FRAP: Full Closed** Control Trim: 2
Run 2	Heat: High FRAP: Full Open Control Trim: 3	Heat: High FRAP: Full Open Control Trim: 3	Heat: Med FRAP: Full Closed Control Trim: 2	Heat: Low FRAP: Open 3/8" Control Trim: 2

\*Minimum setting on heat setting low, control trim 2, FRAP rod fully closed was determined to cause a fire out condition. Repeated with FRAP rod at 3/8" open.

## **1.2 - Procedures and Results Summary**

### **TESTING PROCEDURE**

The PS35-C was tested in accordance with the U.S. EPA 40 CFR Part 60, Subpart AAA – Standards of Performance for New Residential Wood Heaters using ASTM E2515 and ASTM E2779. The model was tested for thermal efficiency and carbon monoxide (CO) emissions in accordance with CSA B415.1-10. The fuel used for certification testing was Somerset Hard wood pellet fuel; this fuel was graded as Premium by the Pellet Fuels Institute and was produced at registered mill # 16016. Particulate emissions were measured using dual sampling trains consisting of two sets of filters (front and back).

### **RUN NARRATIVE**

Two test runs were performed. The unit was installed and adjusted in accordance with the manufacturer's instructions.

The manufacturer's instructions specified operating the preburn and high burn segments at maximum heat setting, and the trim switch set to +3, and the Feed Rate Adjustment Plate (FRAP) at the fully open position. The medium burn segment was operated at heat setting Medium the trim switch set to +2, and the FRAP at the full closed position. The low burn segment was operated for run 1 with the heat setting switch at the Low position, the trim at 2, and the FRAP fully closed.

The fire went out during run 1 (per the definitions of ASTM E2779), so the test run was aborted. The FRAP position was determined as the cause, so a second test run was performed. Identical settings were used for the High and Medium segments, and the trim and heat setting were the same for the Low segment, but the FRAP position was altered to 3/8" open. All burn criteria were achieved for this test run, so its results are valid for use as the integrated test run.

### **RESULTS SUMMARY**

Proportionality results of the integrated test run, in addition to all other validity criteria, were within specified limits, and no sampling anomalies occurred. All burn rate categories were achieved. Therefore, this test run is considered valid.

The PS35-C results indicate an average particulate emission rate of 1.02 g/hr. The results are within the emission limit of 2.0 g/h for affected appliances manufactured on or after May 15, 2020.

The heater demonstrated an average thermal efficiency of 68.8%. The calculated CO emission rate was 0.15 g/min.

Upon completion of emissions certification testing, the sample unit was sealed and will be stored by the manufacturer in accordance with the requirements of the CFR.

### 1.3 - Appliance Description

**Appliance Manufacturer:** Hearth & Home Technologies

**Pellet Stove Model:** PS35-C

**Type:** Freestanding, air-circulating type, pellet-fired room heater.

The PS35-C's principle elements include a fuel hopper, cold rolled steel burn pot, and electrical fuel feed, combustion air, and convection air supply systems. The frame of the unit is constructed of mild steel, as is the outer fascia.

Combustion products are routed out of the firebox chamber via a baffle-type heat exchanger through a 3-inch diameter flue outlet located on the rear of the unit.

Fuel is supplied from the hopper to the burn pot via a screw-type auger, mounted diagonally. Fuel supply rate is varied by cycling the auger motor as needed.

Ashes fall through the burn pot into a removable ash drawer located at the bottom of the unit. The drawer is accessed through a mild steel door, distinct from the cast aluminum front firebox door, which also features a 13.5 x 10.0" glass panel.

The burn rate is regulated by a user operated rocket switch and physical feed restriction plate (Feed Rate Adjustment Plate or FRAP) located between the auger and hopper. An additional trim setting is located on the control panel inside the appliance.

More detailed information is shown in the manufacturer's design drawings, Appendix C of this report. This information is considered confidential business information (CBI) by the manufacturer and is not included in the non-CBI version of this report.





**Control Photographs**  
PS35-C  
Test Date: 2/28/2019



**Burn Setting Rocker Switch**

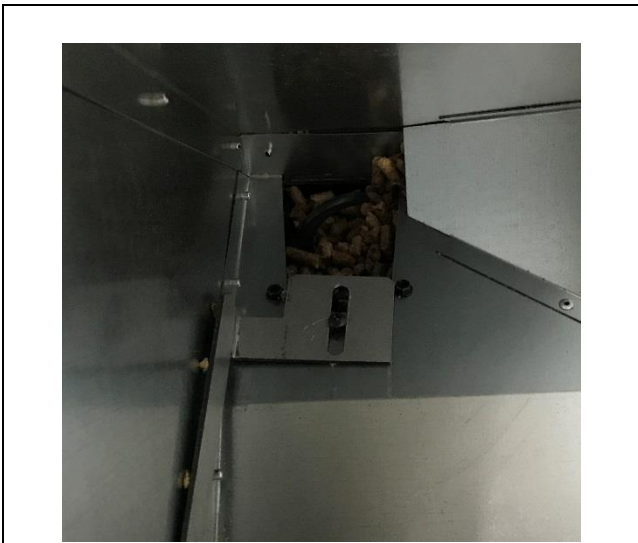

**Feed Rate Adjustment Plate (FRAP)**



**Control Board Trim Access**

**Appliance Photographs**  
PS35-C  
Test Date: 2/28/2019



**PS35-C Front**



**PS35-C Back**



**PS35-C Left**



**PS35-C Right**

# **Section 2**

## **Test Data**

2.1 Test Data by Run

2.2 Sample Analysis & Tares

## PS35-C operating instructions

High Burn Rate setting- Heat setting on high, "FRAP" (Feed Rate Adjustment Plate) fully open.

Control box setting 3.

Medium Burn Rate Setting- Heat setting on medium, FRAP fully closed.

Control box setting 2.

Low Burn Rate Setting- Heat setting on low, FRAP 3/8" from closed.

Control box setting 2.

## **2.1 - Test Data by Run**

Run 1 Notes

*Run Aborted – Fire Out*

## Pellet Heater Preburn Data - ASTM E2779

Manufacturer: Hearth & Home  
 Model: PS35-C  
 Tracking No.: 2356  
 Project No.: 0061PS086E  
 Test Date: 2/27/2019

PB Length: 78 min  
 Recording Interval: 1 min

Averages: 

441	64	-0.04		
-----	----	-------	--	--

Elapsed Time (min)	Scale Reading	Weight Change	Stack (F)	Ambient (F)	Draft ("H2O)	CO2 (%)	CO (%)
0	33.5	-	65	64	0.01		
1	33.5	0	65	64	0.01		
2	33.4	-0.1	87	64	0.01		
3	33.3	-0.1	152	64	0.01		
4	33.3	0	182	63	0.01		
5	33.2	-0.1	218	64	0.01		
6	33.1	-0.1	267	64	0.01		
7	33.0	-0.1	287	64	0.01		
8	33.0	0	305	63	0.01		
9	32.9	-0.1	347	64	0.01		
10	32.7	-0.2	379	64	0.01		
11	32.6	-0.1	402	64	0.01		
12	32.5	-0.1	420	63	0.01		
13	32.4	-0.1	433	63	0.01		
14	32.3	-0.1	443	64	0.01		
15	32.2	-0.1	447	63	0.01		
16	32.2	0	453	63	0.01		
17	32.1	-0.1	461	64	-0.05		
18	32.0	-0.1	465	64	-0.05		
19	31.9	-0.1	472	64	-0.05		
20	31.8	-0.1	473	64	-0.05		
21	31.7	-0.1	473	64	-0.05		
22	31.6	-0.1	475	64	-0.05		
23	31.5	-0.1	474	64	-0.05		
24	31.5	0	475	64	-0.05		
25	31.4	-0.1	475	64	-0.05		
26	31.3	-0.1	480	64	-0.05		
27	31.2	-0.1	485	64	-0.05		
28	31.1	-0.1	487	65	-0.05		
29	31.0	-0.1	487	64	-0.05		

## Pellet Heater Preburn Data - ASTM E2779

Manufacturer: Hearth & Home  
 Model: PS35-C  
 Tracking No.: 2356  
 Project No.: 0061PS086E  
 Test Date: 2/27/2019

PB Length: 78 min  
 Recording Interval: 1 min

Averages: 

441	64	-0.04		
-----	----	-------	--	--

30	31.0	0	488	64	-0.05		
31	30.9	-0.1	487	64	-0.05		
32	30.8	-0.1	482	65	-0.05		
33	30.7	-0.1	483	65	-0.05		
34	30.6	-0.1	485	64	-0.05		
35	30.6	0	487	64	-0.05		
36	30.5	-0.1	488	65	-0.05		
37	30.4	-0.1	490	64	-0.05		
38	30.3	-0.1	488	64	-0.05		
39	30.2	-0.1	484	65	-0.05		
40	30.1	-0.1	485	64	-0.05		
41	30.1	0	488	64	-0.05		
42	30.0	-0.1	494	64	-0.05		
43	29.9	-0.1	495	64	-0.05		
44	29.8	-0.1	494	64	-0.05		
45	29.7	-0.1	495	64	-0.05		
46	29.6	-0.1	496	64	-0.05		
47	29.5	-0.1	493	65	-0.05		
48	29.4	-0.1	498	64	-0.05		
49	29.3	-0.1	496	64	-0.05		
50	29.3	0	493	64	-0.05		
51	29.2	-0.1	492	65	-0.05		
52	29.1	-0.1	492	65	-0.05		
53	29.0	-0.1	494	65	-0.05		
54	28.9	-0.1	499	65	-0.05		
55	28.8	-0.1	501	64	-0.05		
56	28.7	-0.1	501	64	-0.05		
57	28.6	-0.1	499	64	-0.05		
58	28.6	0	498	64	-0.05		
59	28.5	-0.1	499	64	-0.05		
60	34.7	6.2	493	64	-0.05		
61	34.6	-0.1	491	64	-0.05		

## Pellet Heater Preburn Data - ASTM E2779

Manufacturer: Hearth & Home  
 Model: PS35-C  
 Tracking No.: 2356  
 Project No.: 0061PS086E  
 Test Date: 2/27/2019

PB Length: 78 min  
 Recording Interval: 1 min

Averages: 

441	64	-0.04		
-----	----	-------	--	--

62	34.5	-0.1	490	64	-0.05		
63	34.4	-0.1	490	64	-0.05		
64	34.3	-0.1	491	65	-0.05		
65	34.2	-0.1	495	64	-0.05		
66	34.1	-0.1	494	64	-0.05		
67	34.0	-0.1	496	64	-0.05		
68	34.0	0	492	64	-0.05		



**Pellet Heater Test Data - ASTM E2779 / ASTM E2515**

Run: 1  
 Manufacturer: Hearth & Home High Burn End Time: 61  
 Model: PS35-C Medium Burn End Time: 182  
 Tracking No.: 2356 Total Sampling Time: 256 min  
 Project No.: 0061PS086E Recording Interval: 1 min  
 Test Date: 27-Feb-19  
 Beginning Clock Time: 10:21 Background Sample Volume: 0 cubic feet  
 Meter Box Y Factor: 1.022 (1) 0.995 (2) 0 (Amb)  
 Barometric Pressure: Begin Middle End Average  
29.96 30.14 30.12 30.07 "Hg

PM Control Modules: 335, 336  
 Dilution Tunnel MW(dry): 29.00 lb/lb-mole  
 Dilution Tunnel MW(wet): 28.78 lb/lb-mole  
 Dilution Tunnel H2O: 2.00 percent  
 Dilution Tunnel Static: -0.180 "H<sub>2</sub>O  
 Tunnel Area: 0.1963 ft<sup>2</sup>  
 Pitot Tube Cp: 0.99  
 Avg. Tunnel Velocity: 12.63 ft/sec.  
 Initial Tunnel Flow: 146.4 scfm  
 Average Tunnel Flow: 141.7 scfm  
 Post-Test Leak Check (1): 0.000 cfm @ 7 in. Hg  
 Post-Test Leak Check (2): 0.000 cfm @ 9 in. Hg  
 Fuel Moisture (%): 5.966 Dry Basis 5.630 Wet Basis

Velocity Traverse Data									
	Pt.1	Pt.2	Pt.3	Pt.4	Pt.5	Pt.6	Pt.7	Pt.8	Center
Initial dP	0.037	0.042	0.046	0.032	0.031	0.041	0.045	0.039	0.047
Temp:	107	107	107	106	107	107	107	107	107
V <sub>strav</sub>		13.55			ft/sec		V <sub>scent</sub>		14.88
						ft/sec		F <sub>p</sub>	
								0.910	

Elapsed Time (min)	Particulate Sampling Data												Fuel Weight (lb)		Temperature Data (°F)						Stack Gas Data				
	Gas Meter 1 (ft <sup>3</sup> )	Gas Meter 2 (ft <sup>3</sup> )	Sample Rate 1 (cfm)	Sample Rate 2 (cfm)	Orifice dH 1 ("H <sub>2</sub> O)	Meter Temp 1 (°F)	Meter Vacuum 1 ("Hg)	Orifice dH 2 ("H <sub>2</sub> O)	Meter Temp 2 (°F)	Meter Vacuum 2 ("Hg)	Dilution Tunnel (°F)	Tunnel Center dP	Pro. Rate 1	Pro. Rate 2	Scale Reading	Weight Change	Stack	Filter 1	Dryer 1	Filter 2	Dryer 2	Ambient	Draft ("H <sub>2</sub> O)	CO <sub>2</sub> (%)	CO (%)
0	0.000	0.000			0.08	67	-0.07	0.02	68	1.80	105	0.046			33.0		496	64	66	66	68	64	-0.053		
1	0.309	0.383	0.31	0.38	1.36	67	2.00	1.69	67	2.10	105	0.042	200	245	32.9	-0.1	499	66	67	67	69	63	-0.052		
2	0.469	0.581	0.16	0.20	1.36	67	2.00	1.69	67	2.10	105	0.047	98	120	32.8	-0.1	502	67	67	67	69	64	-0.053		
3	0.629	0.779	0.16	0.20	1.35	67	2.00	1.68	67	2.10	105	0.048	97	118	32.7	-0.1	501	67	67	68	69	64	-0.052		
4	0.789	0.978	0.16	0.20	1.35	67	2.02	1.68	67	2.10	105	0.043	102	126	32.7	0.0	502	68	67	68	69	63	-0.052		
5	0.939	1.175	0.15	0.20	1.53	67	2.36	1.61	67	2.00	105	0.044	95	123	32.6	-0.1	503	68	67	68	69	65	-0.052		
6	1.096	1.360	0.16	0.19	1.35	67	2.01	1.30	67	1.50	105	0.046	97	113	32.5	-0.1	502	68	67	68	69	64	-0.053		
7	1.256	1.510	0.16	0.15	1.34	67	1.99	0.95	68	1.10	105	0.043	102	95	32.4	-0.1	504	67	67	69	69	63	-0.052		
8	1.415	1.659	0.16	0.15	1.35	67	1.99	0.95	68	1.10	105	0.046	98	91	32.3	-0.1	503	67	67	69	69	64	-0.052		
9	1.574	1.808	0.16	0.15	1.34	67	2.01	0.94	68	1.10	105	0.048	96	89	32.2	-0.1	503	67	67	69	69	64	-0.053		
10	1.733	1.877	0.16	0.07	1.35	67	1.99	0.22	68	0.10	105	0.047	97	42	32.1	-0.1	501	66	67	69	69	63	-0.052		
11	1.891	2.018	0.16	0.14	1.34	67	2.00	1.09	68	1.30	105	0.044	100	88	32.0	-0.1	501	67	67	69	69	63	-0.052		
12	2.050	2.179	0.16	0.16	1.34	67	2.01	1.09	68	1.30	105	0.044	100	100	31.9	-0.1	500	67	67	69	69	63	-0.052		
13	2.209	2.338	0.16	0.16	1.35	67	1.99	1.08	68	1.30	105	0.043	102	100	31.8	-0.1	502	68	67	70	69	64	-0.052		
14	2.367	2.498	0.16	0.16	1.34	68	1.99	1.09	68	1.30	105	0.044	100	100	31.8	0.0	503	68	67	70	69	63	-0.053		
15	2.526	2.659	0.16	0.16	1.34	68	2.01	1.09	68	1.30	105	0.045	99	99	31.7	-0.1	505	68	67	70	69	64	-0.052		
16	2.685	2.819	0.16	0.16	1.34	68	1.99	1.08	68	1.30	105	0.044	100	100	31.6	-0.1	504	68	67	70	69	64	-0.052		
17	2.844	2.978	0.16	0.16	1.33	68	2.00	1.09	68	1.30	105	0.043	101	100	31.5	-0.1	505	68	67	70	69	64	-0.053		
18	3.002	3.139	0.16	0.16	1.33	68	2.00	1.08	69	1.30	105	0.045	98	99	31.4	-0.1	508	68	67	70	70	64	-0.053		
19	3.161	3.298	0.16	0.16	1.34	68	2.00	1.08	69	1.30	105	0.046	98	97	31.3	-0.1	505	68	67	70	70	64	-0.052		
20	3.319	3.458	0.16	0.16	1.34	68	2.00	1.09	69	1.30	105	0.044	100	100	31.2	-0.1	505	68	67	70	70	63	-0.053		
21	3.478	3.618	0.16	0.16	1.34	68	2.00	1.09	69	1.30	106	0.044	100	100	31.1	-0.1	500	68	67	71	70	63	-0.052		
22	3.637	3.778	0.16	0.16	1.35	68	1.99	1.08	69	1.30	105	0.046	98	97	31.0	-0.1	499	68	67	70	70	64	-0.051		
23	3.796	3.937	0.16	0.16	1.33	68	2.00	1.08	69	1.30	105	0.044	100	99	30.9	-0.1	500	68	67	70	70	64	-0.052		
24	3.955	4.098	0.16	0.16	1.34	69	2.00	1.09	69	1.30	105	0.044	100	100	30.9	0.0	501	68	67	71	70	64	-0.052		
25	4.114	4.257	0.16	0.16	1.34	69	2.00	1.08	70	1.30	105	0.046	98	97	30.8	-0.1	500	68	67	71	70	64	-0.051		
26	4.272	4.417	0.16	0.16	1.33	69	2.00	1.08	70	1.30	105	0.046	97	97	30.7	-0.1	500	68	67	71	70	64	-0.052		
27	4.431	4.577	0.16	0.16	1.34	69	1.99	1.08	70	1.30	105	0.045	99	98	30.6	-0.1	501	68	67	71	70	63	-0.051		
28	4.589	4.737	0.16	0.16	1.34	69	1.99	1.08	70	1.30	104	0.045	98	98	30.5	-0.1	499	68	67	71	70	63	-0.052		
29	4.748	4.897	0.16	0.16	1.34	69	2.00	1.08	70	1.30	104	0.045	99	98	30.4	-0.1	502	68	67	71	70	64	-0.052		
30	4.907	5.057	0.16	0.16	1.34	69	1.99	1.08	70	1.30	105	0.048	96	95	30.3	-0.1	505	68	67	71	70	63	-0.052		
31	5.066	5.217	0.16	0.16	1.34	69	2.01	1.07	70	1.30	104	0.045	99	98	30.2	-0.1	506	69	67	71	70	63	-0.052		
32	5.225	5.376	0.16	0.16	1.32	70	2.01	1.08	70	1.30	104	0.046	98	97	30.1	-0.1	506	69	67	71	70	63	-0.054		
33	5.384	5.537	0.16	0.16	1.34	70	2.01	1.08	71	1.30	105	0.044	100	100	30.0	-0.1	504	69	67	71	70	63	-0.052		
34	5.543	5.697	0.16	0.16	1.34	70	2.00	1.08	71	1.30	104	0.045	99	98	30.0	0.0	502	69	67	71	70	64	-0.052		
35	5.702	5.856	0.16	0.16	1.33	70	2.01	1.08	71	1.30	104	0.046	98	96	29.9	-0.1	497	68	67	71	70	63	-0.052		
36	5.861	6.017	0.16	0.16	1.33	70	2.00	1.09	71	1.30	104	0.047	96	96	29.8	-0.1	497	68	67	71	70	63	-0.052		
37	6.019	6.177	0.16	0.16	1.34	70	2.00	1.08	71	1.30	104	0.044	99	99	29.7	-0.1	494	68	67	71	70	63	-0.052		
38	6.178	6.336	0.16	0.16	1.34	70	2.01	1.09	71	1.30	104	0.045	99	97	29.6	-0.1	489	68	68	71	70	64	-0.051		
39	6.337	6.497	0.16	0.16	1.34	70	2.00	1.08	71	1.30	103	0.045	99	99	29.6	0.0	486	68	68	71	70	63	-0.052		
40	6.497	6.657	0.16	0.16	1.34	70	2.00	1.08	71	1.30	103	0.047	97	96	29.5	-0.1	487	68	68	71	70	63	-0.051		
41	6.657	6.817	0.16	0.16	1.34	70	2.02	1.08	71	1.30	103	0.046	98	97	29.4	-0.1	489	68	68	71	70	64	-0.053		
42	6.816	6.977	0.16	0.16	1.34	70	2.00	1.08	72	1.30	103	0.046	97	97	29.3	-0.1	491	68	67	71	70	64	-0.051		
43	6.975	7.137	0.16	0.16	1.33	71	2.00	1.07	72	1.30	103	0.044	99	99	29.2	-0.1	492	68	67	71	70	63	-0.052		
44	7.134	7.297	0.16	0.16	1.33	71	2.02	1.08	72	1.30	103	0.047	96	96	29.1	-0.1	491	68	67	71	70	63	-0.051		
45	7.293	7.457	0.16	0.16	1.34	71	2.01	1.08	72	1.30	103	0.048	95	95	29.0	-0.1	491	68	67	71	70	63	-0.053		
46	7.452	7.618	0.16	0.16	1.33	71	2.02	1.08	72	1.30	103	0.043	101	101	28.9	-0.1	494	68	67	71	70	63	-0.053		
47	7.611	7.778	0.16	0.16	1.34	71	2.01	1.08	72	1.30	103	0.045	98	98	28.9	0.0	493	68	67	71	70	64	-0.053		
48	7.770	7.938	0.16	0.16	1.35	71	2.01	1.09	72	1.30	103	0.046	97	97	28.8	-0.1	497	68	67	71	70	63	-0.052		

# Pellet Heater Test Data - ASTM E2779 / ASTM E2515

Run: 1

Manufacturer: Hearth & Home High Burn End Time: 61  
 Model: PS35-C Medium Burn End Time: 182  
 Tracking No.: 2356 Total Sampling Time: 256 min  
 Project No.: 0061PS086E Recording Interval: 1 min  
 Test Date: 27-Feb-19  
 Beginning Clock Time: 10:21 Background Sample Volume: 0 cubic feet

Meter Box Y Factor: 1.022 (1) 0.995 (2) 0 (Amb)

Barometric Pressure: Begin Middle End Average  
29.96 30.14 30.12 30.07 "Hg

PM Control Modules: 335, 336  
 Dilution Tunnel MW(dry): 29.00 lb/lb-mole  
 Dilution Tunnel MW(wet): 28.78 lb/lb-mole  
 Dilution Tunnel H2O: 2.00 percent  
 Dilution Tunnel Static: -0.180 "H<sub>2</sub>O  
 Tunnel Area: 0.1963 ft<sup>2</sup>  
 Pitot Tube Cp: 0.99

Avg. Tunnel Velocity: 12.63 ft/sec.  
 Initial Tunnel Flow: 146.4 scfm  
 Average Tunnel Flow: 141.7 scfm  
 Post-Test Leak Check (1): 0.000 cfm @ 7 in. Hg  
 Post-Test Leak Check (2): 0.000 cfm @ 9 in. Hg  
 Fuel Moisture (%): 5.966 Dry Basis 5.630 Wet Basis

Velocity Traverse Data									
	Pt.1	Pt.2	Pt.3	Pt.4	Pt.5	Pt.6	Pt.7	Pt.8	Center
Initial dP	0.037	0.042	0.046	0.032	0.031	0.041	0.045	0.039	0.047
Temp:	107	107	107	107	106	107	107	107	107
V <sub>strav</sub>		13.55			ft/sec		V <sub>scent</sub>		14.88
							F <sub>p</sub>		0.910

Elapsed Time (min)	Particulate Sampling Data												Fuel Weight (lb)		Temperature Data (°F)						Stack Gas Data				
	Gas Meter 1 (ft <sup>3</sup> )	Gas Meter 2 (ft <sup>3</sup> )	Sample Rate 1 (cfm)	Sample Rate 2 (cfm)	Orifice dH 1 ("H <sub>2</sub> O)	Meter Temp 1 (°F)	Meter Vacuum 1 ("Hg)	Orifice dH 2 ("H <sub>2</sub> O)	Meter Temp 2 (°F)	Meter Vacuum 2 ("Hg)	Dilution Tunnel (°F)	Tunnel Center dP	Pro. Rate 1	Pro. Rate 2	Scale Reading	Weight Change	Stack	Filter 1	Dryer 1	Filter 2	Dryer 2	Ambient	Draft ("H <sub>2</sub> O)	CO <sub>2</sub> (%)	CO (%)
49	7.929	8.099	0.16	0.16	1.35	71	2.01	1.09	72	1.30	103	0.044	99	99	28.7	-0.1	501	68	67	71	70	63	-0.054		
50	8.089	8.258	0.16	0.16	1.35	71	2.02	1.09	72	1.30	103	0.047	97	95	28.6	-0.1	502	68	67	71	70	63	-0.053		
51	8.249	8.419	0.16	0.16	1.33	71	2.01	1.09	72	1.30	103	0.045	99	98	28.5	-0.1	501	68	67	71	70	63	-0.052		
52	8.408	8.580	0.16	0.16	1.34	71	2.01	1.09	72	1.30	104	0.045	98	98	28.4	-0.1	504	68	67	71	70	63	-0.053		
53	8.567	8.739	0.16	0.16	1.34	71	2.01	1.08	72	1.30	104	0.044	100	98	28.3	-0.1	505	68	67	71	70	63	-0.053		
54	8.726	8.899	0.16	0.16	1.34	71	2.02	1.08	72	1.30	104	0.045	98	98	28.2	-0.1	501	68	67	71	70	63	-0.052		
55	8.885	9.061	0.16	0.16	1.34	71	2.02	1.08	72	1.30	104	0.042	102	103	28.2	0.0	495	68	67	71	70	63	-0.052		
56	9.045	9.220	0.16	0.16	1.34	71	2.03	1.08	72	1.30	104	0.044	100	98	28.1	-0.1	495	68	67	71	70	63	-0.052		
57	9.204	9.380	0.16	0.16	1.34	71	2.01	1.08	72	1.30	104	0.047	96	96	28.0	-0.1	494	68	67	71	70	63	-0.052		
58	9.363	9.541	0.16	0.16	1.35	71	2.03	1.09	72	1.30	103	0.045	98	98	27.9	-0.1	500	68	67	70	70	63	-0.053		
59	9.523	9.702	0.16	0.16	1.34	71	2.02	1.08	73	1.30	103	0.046	98	97	27.8	-0.1	497	68	67	70	70	63	-0.053		
60	9.682	9.861	0.16	0.16	1.35	71	2.02	1.08	73	1.30	104	0.045	98	97	27.7	-0.1	498	68	67	70	70	62	-0.053		
61	9.842	10.023	0.16	0.16	1.34	71	2.01	1.09	73	1.30	103	0.047	97	97	27.6	-0.1	497	67	67	70	70	63	-0.052		
62	10.002	10.184	0.16	0.16	1.35	72	2.01	1.09	73	1.30	102	0.050	94	93	27.6	0.0	491	68	67	70	70	63	-0.052		
63	10.161	10.344	0.16	0.16	1.34	72	2.03	1.09	73	1.30	102	0.047	96	95	27.5	-0.1	490	68	67	70	70	63	-0.052		
64	10.320	10.504	0.16	0.16	1.34	72	2.02	1.08	73	1.30	102	0.043	100	100	27.4	-0.1	494	68	67	70	70	63	-0.052		
65	10.479	10.666	0.16	0.16	1.34	72	2.03	1.09	73	1.30	103	0.043	100	101	27.3	-0.1	495	68	67	70	70	62	-0.051		
66	10.639	10.826	0.16	0.16	1.34	72	2.03	1.09	73	1.30	103	0.045	99	98	27.3	0.0	493	68	67	70	70	62	-0.052		
67	10.798	10.986	0.16	0.16	1.35	72	2.03	1.08	73	1.30	103	0.045	98	98	27.2	-0.1	490	68	67	70	70	62	-0.051		
68	10.957	11.147	0.16	0.16	1.35	72	2.03	1.09	73	1.30	103	0.043	100	100	27.1	-0.1	490	68	67	70	70	63	-0.052		
69	11.117	11.308	0.16	0.16	1.34	72	2.02	1.08	73	1.30	103	0.043	101	100	27.1	0.0	488	68	67	70	70	63	-0.051		
70	11.276	11.468	0.16	0.16	1.34	72	2.02	1.09	73	1.30	103	0.046	97	96	27.0	-0.1	484	68	67	70	70	63	-0.050		
71	11.436	11.629	0.16	0.16	1.35	72	2.03	1.09	73	1.30	103	0.045	99	98	27.0	0.0	473	68	67	70	70	62	-0.049		
72	11.596	11.789	0.16	0.16	1.34	72	2.03	1.08	73	1.30	102	0.051	93	92	26.9	-0.1	463	68	67	70	70	63	-0.048		
73	11.755	11.950	0.16	0.16	1.34	72	2.03	1.08	73	1.30	102	0.046	97	97	26.9	0.0	456	68	67	70	70	63	-0.047		
74	11.914	12.110	0.16	0.16	1.33	72	2.04	1.09	73	1.30	101	0.048	95	94	26.8	-0.1	449	68	67	70	70	63	-0.047		
75	12.074	12.272	0.16	0.16	1.34	72	2.03	1.09	73	1.30	101	0.043	101	101	26.7	-0.1	446	68	67	70	70	63	-0.046		
76	12.233	12.432	0.16	0.16	1.34	72	2.03	1.09	73	1.30	100	0.045	98	97	26.7	0.0	443	68	67	70	70	63	-0.047		
77	12.392	12.592	0.16	0.16	1.34	72	2.04	1.09	73	1.30	97	0.046	97	96	26.6	-0.1	431	68	67	70	69	62	-0.048		
78	12.552	12.754	0.16	0.16	1.34	72	2.02	1.09	73	1.30	94	0.042	101	101	26.6	0.0	416	68	67	69	69	61	-0.047		
79	12.711	12.914	0.16	0.16	1.35	72	2.04	1.09	73	1.30	91	0.047	95	94	26.6	0.0	401	67	67	69	69	62	-0.045		
80	12.871	13.074	0.16	0.16	1.34	72	2.02	1.09	73	1.30	90	0.049	94	92	26.5	-0.1	394	67	67	69	69	62	-0.044		
81	13.030	13.235	0.16	0.16	1.35	72	2.04	1.09	73	1.30	89	0.044	98	98	26.5	0.0	385	67	67	69	69	62	-0.043		
82	13.190	13.396	0.16	0.16	1.34	72	2.02	1.08	73	1.30	87	0.045	97	97	26.5	0.0	377	67	67	69	69	62	-0.043		
83	13.350	13.557	0.16	0.16	1.34	72	2.02	1.08	73	1.30	87	0.047	95	95	26.4	-0.1	373	67	67	69	69	63	-0.042		
84	13.510	13.717	0.16	0.16	1.34	72	2.04	1.08	73	1.30	86	0.046	96	95	26.4	0.0	370	67	67	68	69	61	-0.041		
85	13.669	13.879	0.16	0.16	1.35	72	2.04	1.08	73	1.30	86	0.044	98	98	26.3	-0.1	365	67	66	68	69	62	-0.041		
86	13.829	14.039	0.16	0.16	1.34	72	2.03	1.08	73	1.30	86	0.042	101	99	26.3	0.0	362	67	66	68	69	62	-0.041		
87	13.988	14.200	0.16	0.16	1.34	72	2.02	1.09	73	1.30	85	0.045	97	97	26.2	-0.1	361	67	66	68	68	62	-0.041		
88	14.148	14.361	0.16	0.16	1.34	72	2.04	1.08	73	1.30	84	0.047	95	94	26.2	0.0	355	66	66	68	68	62	-0.040		
89	14.307	14.522	0.16	0.16	1.34	72	2.03	1.08	73	1.30	84	0.046	95	95	26.2	0.0	356	66	66	68	68	62	-0.040		
90	14.467	14.682	0.16	0.16	1.34	72	2.04	1.09	73	1.30	84	0.048	94	93	26.1	-0.1	354	66	66	67	68	61	-0.040		
91	14.626	14.843	0.16	0.16	1.35	72	2.02	1.09	73	1.30	84	0.046	95	95	26.1	0.0	352	66	66	67	68	62	-0.040		
92	14.786	15.005	0.16	0.16	1.34	72	2.02	1.09	73	1.30	84	0.048	94	94	26.0	-0.1	352	66	66	67	68	61	-0.040		
93	14.946	15.165	0.16	0.16	1.35	72	2.02	1.09	73	1.30	83	0.044	98	97	26.0	0.0	351	66	66	67	68	61	-0.040		
94	15.106	15.326	0.16	0.16	1.34	72	2.03	1.09	73	1.30	83	0.047	95	94	26.0	0.0	348	66	66	67	68	61	-0.039		
95	15.266	15.487	0.16	0.16	1.33	72	2.02	1.09	73	1.30	83	0.045	97	96	25.9	-0.1	347	66	66	67	68	61	-0.039		
96	15.426	15.648	0.16	0.16	1.34	72	2.02	1.08	73	1.30	83	0.048	94	93	25.9	0.0	344	66	66	67	67	61	-0.039		
97	15.585	15.808	0.16	0.16	1.34	72	2.04	1.09	73	1.30	83	0.046	95	95	25.9	0.0	342	66	65	67	67	62	-0.039		

Pellet Heater Test Data - ASTM E2779 / ASTM E2515

Run: 1  
 Manufacturer: Hearth & Home High Burn End Time: 61  
 Model: PS35-C Medium Burn End Time: 182  
 Tracking No.: 2356 Total Sampling Time: 256 min  
 Project No.: 0061PS086E Recording Interval: 1 min  
 Test Date: 27-Feb-19  
 Beginning Clock Time: 10:21 Background Sample Volume: 0 cubic feet  
 Meter Box Y Factor: 1.022 (1) 0.995 (2) 0 (Amb)  
 Barometric Pressure: Begin Middle End Average  
29.96 30.14 30.12 30.07 <sup>°Hg</sup>

PM Control Modules: 335, 336  
 Dilution Tunnel MW(dry): 29.00 lb/lb-mole  
 Dilution Tunnel MW(wet): 28.78 lb/lb-mole  
 Dilution Tunnel H2O: 2.00 percent  
 Dilution Tunnel Static: -0.180 <sup>°H<sub>2</sub>O</sup>  
 Tunnel Area: 0.1963 ft<sup>2</sup>  
 Pitot Tube Cp: 0.99

Avg. Tunnel Velocity: 12.63 ft/sec.  
 Initial Tunnel Flow: 146.4 scfm  
 Average Tunnel Flow: 141.7 scfm  
 Post-Test Leak Check (1): 0.000 cfm @ 7 in. Hg  
 Post-Test Leak Check (2): 0.000 cfm @ 9 in. Hg  
 Fuel Moisture (%): 5.966 Dry Basis 5.630 Wet Basis

	Pt.1	Pt.2	Pt.3	Pt.4	Pt.5	Pt.6	Pt.7	Pt.8	Center
Initial dP	<u>0.037</u>	<u>0.042</u>	<u>0.046</u>	<u>0.032</u>	<u>0.031</u>	<u>0.041</u>	<u>0.045</u>	<u>0.039</u>	<u>0.047</u>
Temp:	<u>107</u>	<u>107</u>	<u>107</u>	<u>106</u>	<u>107</u>	<u>106</u>	<u>107</u>	<u>107</u>	<u>107</u>

V<sub>strav</sub> 13.55 ft/sec V<sub>scent</sub> 14.88 ft/sec F<sub>p</sub> 0.910

Elapsed Time (min)	Particulate Sampling Data												Fuel Weight (lb)		Temperature Data (°F)						Stack Gas Data				
	Gas Meter 1 (ft <sup>3</sup> )	Gas Meter 2 (ft <sup>3</sup> )	Sample Rate 1 (cfm)	Sample Rate 2 (cfm)	Orifice dH 1 (°H <sub>2</sub> O)	Meter Temp 1 (°F)	Meter Vacuum 1 (°Hg)	Orifice dH 2 (°H <sub>2</sub> O)	Meter Temp 2 (°F)	Meter Vacuum 2 (°Hg)	Dilution Tunnel (°F)	Tunnel Center dP	Pro. Rate 1	Pro. Rate 2	Scale Reading	Weight Change	Stack	Filter 1	Dryer 1	Filter 2	Dryer 2	Ambient	Draft (°H <sub>2</sub> O)	CO <sub>2</sub> (%)	CO (%)
98	15.745	15.969	0.16	0.16	1.34	72	2.03	1.09	73	1.30	83	0.043	99	99	25.8	-0.1	344	66	65	67	67	61	-0.039		
99	15.904	16.130	0.16	0.16	1.34	72	2.02	1.08	73	1.30	83	0.048	93	93	25.7	-0.1	348	65	65	66	67	61	-0.040		
100	16.063	16.291	0.16	0.16	1.34	72	2.02	1.08	73	1.30	83	0.045	96	96	25.7	0.0	351	65	65	66	67	61	-0.040		
101	16.223	16.451	0.16	0.16	1.34	72	2.02	1.08	73	1.30	83	0.045	97	96	25.6	-0.1	351	65	65	66	67	61	-0.040		
102	16.382	16.613	0.16	0.16	1.35	72	2.04	1.08	73	1.30	83	0.045	96	97	25.6	0.0	350	65	65	66	67	61	-0.039		
103	16.542	16.773	0.16	0.16	1.34	72	2.02	1.08	73	1.30	83	0.043	99	98	25.6	0.0	351	65	65	66	67	62	-0.040		
104	16.701	16.934	0.16	0.16	1.34	72	2.04	1.09	73	1.30	83	0.045	96	96	25.5	-0.1	346	65	65	66	67	61	-0.039		
105	16.861	17.095	0.16	0.16	1.35	72	2.04	1.09	73	1.30	83	0.050	92	91	25.5	0.0	345	65	65	66	67	61	-0.040		
106	17.021	17.256	0.16	0.16	1.34	72	2.04	1.09	73	1.30	83	0.044	98	97	25.4	-0.1	349	65	65	66	67	61	-0.040		
107	17.181	17.416	0.16	0.16	1.34	72	2.04	1.09	73	1.30	83	0.047	95	94	25.4	0.0	349	65	65	66	66	61	-0.040		
108	17.340	17.577	0.16	0.16	1.34	72	2.04	1.09	72	1.30	82	0.042	100	100	25.4	0.0	347	65	65	66	66	61	-0.040		
109	17.500	17.738	0.16	0.16	1.34	72	2.02	1.09	72	1.30	83	0.045	97	97	25.3	-0.1	348	65	65	66	66	61	-0.040		
110	17.659	17.899	0.16	0.16	1.34	72	2.02	1.09	72	1.30	82	0.043	99	99	25.3	0.0	347	65	65	66	66	61	-0.040		
111	17.819	18.060	0.16	0.16	1.33	71	2.04	1.09	72	1.30	82	0.047	95	94	25.2	-0.1	344	64	65	66	66	61	-0.039		
112	17.978	18.221	0.16	0.16	1.34	71	2.02	1.09	72	1.30	82	0.046	95	95	25.2	0.0	340	64	64	66	66	61	-0.039		
113	18.137	18.381	0.16	0.16	1.34	71	2.02	1.08	72	1.30	82	0.044	98	97	25.2	0.0	338	64	64	66	66	61	-0.038		
114	18.297	18.542	0.16	0.16	1.35	71	2.04	1.09	72	1.30	83	0.041	102	101	25.1	-0.1	338	64	64	66	66	61	-0.039		
115	18.456	18.703	0.16	0.16	1.34	71	2.04	1.09	72	1.30	82	0.045	96	96	25.1	0.0	342	64	64	65	66	61	-0.039		
116	18.616	18.864	0.16	0.16	1.34	71	2.04	1.08	72	1.30	82	0.045	97	96	25.0	-0.1	339	64	64	65	66	61	-0.039		
117	18.775	19.025	0.16	0.16	1.34	71	2.04	1.09	72	1.30	82	0.046	95	95	25.0	0.0	337	64	64	65	66	61	-0.038		
118	18.936	19.186	0.16	0.16	1.34	71	2.04	1.08	72	1.30	82	0.045	98	96	25.0	0.0	335	64	64	65	66	61	-0.038		
119	19.095	19.347	0.16	0.16	1.34	71	2.05	1.09	72	1.30	82	0.049	92	92	24.9	-0.1	339	64	64	65	66	61	-0.039		
120	19.255	19.507	0.16	0.16	1.34	71	2.03	1.09	72	1.30	82	0.045	97	96	24.9	0.0	339	64	64	65	66	61	-0.039		
121	19.414	19.668	0.16	0.16	1.33	71	2.04	1.09	72	1.30	82	0.045	96	96	24.8	-0.1	342	64	64	65	66	61	-0.039		
122	19.573	19.829	0.16	0.16	1.33	71	2.04	1.09	72	1.30	82	0.046	95	95	24.8	0.0	342	64	64	65	66	61	-0.039		
123	19.733	19.990	0.16	0.16	1.34	71	2.03	1.09	72	1.30	82	0.045	97	96	24.7	-0.1	343	64	64	65	65	61	-0.038		
124	19.892	20.150	0.16	0.16	1.33	71	2.04	1.08	72	1.30	82	0.043	99	98	24.7	0.0	341	64	64	65	65	61	-0.038		
125	20.051	20.311	0.16	0.16	1.34	71	2.04	1.09	72	1.30	82	0.047	94	94	24.7	0.0	335	64	64	65	65	61	-0.038		
126	20.211	20.473	0.16	0.16	1.34	71	2.04	1.09	72	1.30	82	0.045	97	97	24.6	-0.1	333	64	64	65	65	61	-0.038		
127	20.370	20.633	0.16	0.16	1.34	71	2.04	1.09	72	1.30	81	0.047	94	94	24.6	0.0	334	64	64	65	65	61	-0.038		
128	20.530	20.794	0.16	0.16	1.35	71	2.05	1.09	72	1.30	81	0.047	95	94	24.6	0.0	330	64	64	65	65	61	-0.038		
129	20.690	20.955	0.16	0.16	1.35	71	2.05	1.08	72	1.30	81	0.048	94	93	24.5	-0.1	329	64	64	65	65	61	-0.038		
130	20.850	21.116	0.16	0.16	1.34	71	2.04	1.08	72	1.30	81	0.049	93	92	24.5	0.0	324	64	64	65	65	61	-0.036		
131	21.009	21.276	0.16	0.16	1.34	71	2.03	1.09	72	1.30	81	0.046	95	95	24.5	0.0	322	64	63	65	65	61	-0.036		
132	21.169	21.437	0.16	0.16	1.33	71	2.03	1.09	72	1.30	81	0.045	97	96	24.4	-0.1	328	64	63	65	65	61	-0.038		
133	21.328	21.598	0.16	0.16	1.33	71	2.05	1.09	72	1.30	81	0.047	94	94	24.4	0.0	330	64	63	65	65	61	-0.037		
134	21.487	21.759	0.16	0.16	1.34	71	2.05	1.09	72	1.30	81	0.049	92	92	24.3	-0.1	333	64	63	65	65	61	-0.038		
135	21.646	21.919	0.16	0.16	1.34	71	2.03	1.09	72	1.30	81	0.049	92	92	24.3	0.0	332	64	63	65	65	61	-0.038		
136	21.806	22.081	0.16	0.16	1.34	71	2.04	1.08	72	1.30	81	0.043	99	99	24.3	0.0	329	64	63	65	65	60	-0.037		
137	21.965	22.241	0.16	0.16	1.34	71	2.03	1.08	72	1.30	81	0.045	96	96	24.2	-0.1	330	64	63	65	65	61	-0.038		
138	22.124	22.402	0.16	0.16	1.34	71	2.03	1.09	72	1.30	81	0.049	92	92	24.2	0.0	331	64	63	65	65	61	-0.037		
139	22.284	22.563	0.16	0.16	1.34	71	2.05	1.09	72	1.30	81	0.046	96	95	24.1	-0.1	331	64	63	65	65	60	-0.037		
140	22.444	22.724	0.16	0.16	1.34	71	2.05	1.09	72	1.30	81	0.046	96	95	24.1	0.0	328	64	63	65	65	61	-0.038		
141	22.603	22.884	0.16	0.16	1.34	71	2.05	1.08	72	1.30	81	0.046	95	95	24.1	0.0	326	64	63	65	64	60	-0.037		
142	22.762	23.045	0.16	0.16	1.34	71	2.03	1.09	72	1.30	81	0.047	94	94	24.0	-0.1	327	64	63	65	64	61	-0.037		
143	22.921	23.206	0.16	0.16	1.34	71	2.03	1.09	72	1.30	80	0.045	96	96	24.0	0.0	328	64	63	65	64	60	-0.038		
144	23.080	23.366	0.16	0.16	1.34	71	2.04	1.09	72	1.30	80	0.046	95	95	23.9	-0.1	330	64	63	65	64	60	-0.038		
145	23.239	23.527	0.16	0.16	1.34	71	2.03	1.09	72	1.30	80	0.046	95	95	23.9	0.0	325	64	63	65	64	61	-0.036		
146	23.398	23.688	0.16	0.16	1.34	71	2.04	1.08	72	1.30	80	0.045	96	96	23.9	0.0	327	63	63	64	64	61	-0.037		

**Pellet Heater Test Data - ASTM E2779 / ASTM E2515**

Run: 1

Manufacturer: Hearth & Home High Burn End Time: 61  
 Model: PS35-C Medium Burn End Time: 182  
 Tracking No.: 2356 Total Sampling Time: 256 min  
 Project No.: 0061PS086E Recording Interval: 1 min  
 Test Date: 27-Feb-19  
 Beginning Clock Time: 10:21 Background Sample Volume: 0 cubic feet

Meter Box Y Factor: 1.022 (1) 0.995 (2) 0 (Amb)

Barometric Pressure: Begin Middle End Average  
29.96 30.14 30.12 30.07 "Hg

PM Control Modules: 335, 336

Dilution Tunnel MW(dry): 29.00 lb/lb-mole  
 Dilution Tunnel MW(wet): 28.78 lb/lb-mole  
 Dilution Tunnel H2O: 2.00 percent  
 Dilution Tunnel Static: -0.180 "H<sub>2</sub>O  
 Tunnel Area: 0.1963 ft<sup>2</sup>  
 Pitot Tube Cp: 0.99

Avg. Tunnel Velocity: 12.63 ft/sec.  
 Initial Tunnel Flow: 146.4 scfm  
 Average Tunnel Flow: 141.7 scfm  
 Post-Test Leak Check (1): 0.000 cfm @ 7 in. Hg  
 Post-Test Leak Check (2): 0.000 cfm @ 9 in. Hg  
 Fuel Moisture (%): 5.966 Dry Basis 5.630 Wet Basis

Velocity Traverse Data									
	Pt.1	Pt.2	Pt.3	Pt.4	Pt.5	Pt.6	Pt.7	Pt.8	Center
Initial dP	0.037	0.042	0.046	0.032	0.031	0.041	0.045	0.039	0.047
Temp:	107	107	107	106	107	107	107	107	107
	V <sub>strav</sub> 13.55 ft/sec			V <sub>scent</sub> 14.88 ft/sec			F <sub>p</sub> 0.910		

Elapsed Time (min)	Particulate Sampling Data												Fuel Weight (lb)		Temperature Data (°F)						Stack Gas Data				
	Gas Meter 1 (ft <sup>3</sup> )	Gas Meter 2 (ft <sup>3</sup> )	Sample Rate 1 (cfm)	Sample Rate 2 (cfm)	Orifice dH 1 ("H <sub>2</sub> O)	Meter Temp 1 (°F)	Meter Vacuum 1 ("Hg)	Orifice dH 2 ("H <sub>2</sub> O)	Meter Temp 2 (°F)	Meter Vacuum 2 ("Hg)	Dilution Tunnel (°F)	Tunnel Center dP	Pro. Rate 1	Pro. Rate 2	Scale Reading	Weight Change	Stack	Filter 1	Dryer 1	Filter 2	Dryer 2	Ambient	Draft ("H <sub>2</sub> O)	CO <sub>2</sub> (%)	CO (%)
147	23.558	23.849	0.16	0.16	1.35	71	2.04	1.08	72	1.30	80	0.044	98	97	23.8	-0.1	328	64	63	64	64	61	-0.037		
148	23.717	24.009	0.16	0.16	1.34	71	2.03	1.09	72	1.30	81	0.043	99	98	23.8	0.0	335	63	63	64	64	61	-0.038		
149	23.876	24.170	0.16	0.16	1.34	71	2.05	1.09	72	1.30	81	0.044	97	97	23.7	-0.1	335	63	63	64	64	60	-0.038		
150	24.036	24.331	0.16	0.16	1.34	71	2.04	1.09	72	1.30	80	0.045	97	96	23.7	0.0	334	63	63	64	64	60	-0.038		
151	24.195	24.491	0.16	0.16	1.34	71	2.04	1.09	72	1.30	81	0.044	97	97	23.7	0.0	332	63	63	64	64	61	-0.037		
152	24.354	24.652	0.16	0.16	1.33	71	2.03	1.08	72	1.30	80	0.045	96	96	23.6	-0.1	332	63	63	64	64	60	-0.037		
153	24.513	24.813	0.16	0.16	1.33	71	2.04	1.09	72	1.30	80	0.048	93	93	23.6	0.0	330	63	63	64	64	60	-0.037		
154	24.672	24.973	0.16	0.16	1.34	71	2.05	1.09	72	1.30	80	0.049	92	92	23.6	0.0	325	63	63	64	64	60	-0.036		
155	24.831	25.134	0.16	0.16	1.33	71	2.05	1.09	72	1.30	80	0.048	93	93	23.5	-0.1	328	63	63	64	64	60	-0.038		
156	24.990	25.296	0.16	0.16	1.34	71	2.06	1.08	72	1.30	80	0.048	93	94	23.5	0.0	333	63	63	64	64	60	-0.038		
157	25.149	25.456	0.16	0.16	1.34	70	2.05	1.08	71	1.30	81	0.046	96	95	23.4	-0.1	334	63	63	64	64	61	-0.038		
158	25.308	25.616	0.16	0.16	1.34	70	2.05	1.09	71	1.30	81	0.045	97	96	23.4	0.0	334	63	62	64	64	60	-0.038		
159	25.468	25.777	0.16	0.16	1.34	70	2.06	1.08	71	1.30	81	0.046	96	96	23.3	-0.1	335	63	63	64	64	61	-0.038		
160	25.628	25.938	0.16	0.16	1.33	70	2.04	1.09	71	1.30	81	0.045	97	97	23.3	0.0	335	63	62	64	64	61	-0.038		
161	25.786	26.099	0.16	0.16	1.34	70	2.05	1.09	71	1.30	80	0.048	93	93	23.3	0.0	332	63	62	64	64	60	-0.038		
162	25.946	26.259	0.16	0.16	1.33	70	2.05	1.09	71	1.30	80	0.045	97	96	23.2	-0.1	328	63	62	64	64	61	-0.038		
163	26.104	26.421	0.16	0.16	1.34	70	2.04	1.09	71	1.30	81	0.045	96	97	23.2	0.0	328	63	62	64	64	60	-0.038		
164	26.263	26.581	0.16	0.16	1.33	70	2.04	1.09	71	1.30	81	0.045	97	96	23.2	0.0	329	63	62	64	64	60	-0.037		
165	26.422	26.741	0.16	0.16	1.34	70	2.04	1.09	71	1.30	80	0.049	92	92	23.1	-0.1	329	63	62	64	64	61	-0.038		
166	26.581	26.903	0.16	0.16	1.34	70	2.04	1.09	71	1.30	80	0.047	94	95	23.1	0.0	331	63	62	64	64	60	-0.037		
167	26.740	27.063	0.16	0.16	1.33	70	2.04	1.08	71	1.30	81	0.045	97	96	23.1	0.0	330	63	62	64	64	60	-0.038		
168	26.899	27.223	0.16	0.16	1.34	70	2.05	1.08	71	1.30	81	0.046	96	95	23.0	-0.1	333	63	62	64	64	60	-0.038		
169	27.059	27.384	0.16	0.16	1.34	70	2.05	1.09	71	1.30	81	0.046	96	96	23.0	0.0	332	63	62	64	64	60	-0.038		
170	27.218	27.545	0.16	0.16	1.33	70	2.06	1.08	71	1.30	81	0.044	98	98	22.9	-0.1	335	63	62	64	64	60	-0.038		
171	27.377	27.706	0.16	0.16	1.33	70	2.04	1.08	71	1.30	81	0.043	99	99	22.9	0.0	341	63	62	64	64	60	-0.039		
172	27.536	27.866	0.16	0.16	1.33	70	2.06	1.09	71	1.30	81	0.047	94	94	22.8	-0.1	342	63	62	64	64	61	-0.038		
173	27.694	28.028	0.16	0.16	1.33	70	2.06	1.09	71	1.30	81	0.043	98	99	22.8	0.0	346	63	62	64	64	61	-0.040		
174	27.853	28.187	0.16	0.16	1.34	70	2.06	1.09	71	1.30	81	0.046	96	94	22.7	-0.1	344	63	62	64	64	60	-0.039		
175	28.012	28.348	0.16	0.16	1.33	70	2.06	1.09	71	1.30	82	0.046	96	96	22.7	0.0	347	63	62	64	63	60	-0.039		
176	28.171	28.509	0.16	0.16	1.34	70	2.06	1.09	71	1.30	81	0.046	96	96	22.7	0.0	346	63	62	64	63	60	-0.039		
177	28.330	28.670	0.16	0.16	1.33	70	2.05	1.08	71	1.30	81	0.049	93	93	22.6	-0.1	339	63	62	64	63	60	-0.039		
178	28.490	28.830	0.16	0.16	1.34	70	2.04	1.08	71	1.30	81	0.045	97	96	22.6	0.0	334	63	62	64	63	60	-0.037		
179	28.649	28.991	0.16	0.16	1.34	70	2.06	1.09	71	1.30	81	0.044	98	98	22.6	0.0	334	63	62	64	63	60	-0.037		
180	28.808	29.152	0.16	0.16	1.33	70	2.04	1.08	71	1.30	81	0.044	98	98	22.5	-0.1	334	63	62	64	63	60	-0.038		
181	28.966	29.312	0.16	0.16	1.32	70	2.07	1.08	71	1.30	81	0.045	96	96	22.5	0.0	335	63	62	64	63	60	-0.038		
182	29.125	29.473	0.16	0.16	1.33	70	2.05	1.08	71	1.30	81	0.047	94	95	22.4	-0.1	336	63	62	64	63	60	-0.041		
183	29.284	29.634	0.16	0.16	1.34	70	2.05	1.09	71	1.30	79	0.046	95	95	22.4	0.0	328	63	62	64	63	60	-0.038		
184	29.443	29.794	0.16	0.16	1.33	70	2.06	1.09	71	1.30	78	0.047	94	94	22.4	0.0	317	63	62	64	63	60	-0.037		
185	29.602	29.955	0.16	0.16	1.34	70	2.06	1.09	71	1.30	77	0.043	98	98	22.4	0.0	310	63	62	64	63	60	-0.036		
186	29.761	30.116	0.16	0.16	1.34	70	2.06	1.08	71	1.30	77	0.045	96	96	22.4	0.0	301	63	62	64	63	60	-0.034		
187	29.921	30.277	0.16	0.16	1.33	70	2.06	1.08	71	1.30	76	0.046	96	95	22.3	-0.1	297	63	62	64	63	60	-0.034		
188	30.079	30.437	0.16	0.16	1.34	70	2.06	1.08	71	1.30	76	0.048	92	93	22.3	0.0	293	63	62	64	63	60	-0.033		
189	30.238	30.598	0.16	0.16	1.33	70	2.04	1.09	71	1.30	75	0.044	97	97	22.3	0.0	285	63	62	64	63	60	-0.032		
190	30.397	30.759	0.16	0.16	1.34	70	2.05	1.08	71	1.30	75	0.046	95	95	22.3	0.0	280	63	62	64	63	60	-0.032		
191	30.556	30.919	0.16	0.16	1.33	70	2.07	1.08	71	1.30	75	0.048	93	92	22.2	-0.1	279	63	62	64	63	60	-0.031		
192	30.714	31.080	0.16	0.16	1.34	70	2.06	1.08	71	1.30	74	0.045	95	96	22.2	0.0	274	63	62	64	63	60	-0.031		
193	30.873	31.241	0.16	0.16	1.34	70	2.06	1.08	71	1.30	74	0.045	96	96	22.2	0.0	268	62	62	63	63	60	-0.030		
194	31.032	31.401	0.16	0.16	1.34	70	2.06	1.08	71	1.30	77	0.007	244	242	22.2	0.0	268	62	62	63	63	60	-0.030		
195	31.192	31.562	0.16	0.16	1.34	70	2.04	1.09	71	1.30	81	0.006	266	265	22.1	-0.1	269	63	62	64	63	60	-0.031		

# Pellet Heater Test Data - ASTM E2779 / ASTM E2515

Run: 1

Manufacturer: Hearth & Home High Burn End Time: 61  
 Model: P535-C Medium Burn End Time: 182  
 Tracking No.: 2356 Total Sampling Time: 256 min  
 Project No.: 0061PS086E Recording Interval: 1 min  
 Test Date: 27-Feb-19  
 Beginning Clock Time: 10:21 Background Sample Volume: 0 cubic feet

Meter Box Y Factor: 1.022 (1) 0.995 (2) 0 (Amb)

Barometric Pressure: 29.96 30.14 30.12 30.07 "Hg

PM Control Modules: 335, 336  
 Dilution Tunnel MW(dry): 29.00 lb/lb-mole  
 Dilution Tunnel MW(wet): 28.78 lb/lb-mole  
 Dilution Tunnel H2O: 2.00 percent  
 Dilution Tunnel Static: -0.180 "H<sub>2</sub>O  
 Tunnel Area: 0.1963 ft<sup>2</sup>  
 Pitot Tube Cp: 0.99

Avg. Tunnel Velocity: 12.63 ft/sec.  
 Initial Tunnel Flow: 146.4 scfm  
 Average Tunnel Flow: 141.7 scfm  
 Post-Test Leak Check (1): 0.000 cfm @ 7 in. Hg  
 Post-Test Leak Check (2): 0.000 cfm @ 9 in. Hg  
 Fuel Moisture (%): 5.966 Dry Basis 5.630 Wet Basis

Velocity Traverse Data									
	Pt.1	Pt.2	Pt.3	Pt.4	Pt.5	Pt.6	Pt.7	Pt.8	Center
Initial dP	0.037	0.042	0.046	0.032	0.031	0.041	0.045	0.039	0.047
Temp:	107	107	107	107	106	107	107	107	107
V <sub>strav</sub>	13.55			ft/sec			V <sub>scent</sub> 14.88		
F <sub>p</sub>	0.910			ft/sec					

Elapsed Time (min)	Particulate Sampling Data												Fuel Weight (lb)		Temperature Data (°F)						Stack Gas Data				
	Gas Meter 1 (ft <sup>3</sup> )	Gas Meter 2 (ft <sup>3</sup> )	Sample Rate 1 (cfm)	Sample Rate 2 (cfm)	Orifice dH 1 ("H <sub>2</sub> O)	Meter Temp 1 (°F)	Meter Vacuum 1 ("Hg)	Orifice dH 2 ("H <sub>2</sub> O)	Meter Temp 2 (°F)	Meter Vacuum 2 ("Hg)	Dilution Tunnel (°F)	Tunnel Center dP	Pro. Rate 1	Pro. Rate 2	Scale Reading	Weight Change	Stack	Filter 1	Dryer 1	Filter 2	Dryer 2	Ambient	Draft ("H <sub>2</sub> O)	CO <sub>2</sub> (%)	CO (%)
196	31.351	31.723	0.16	0.16	1.35	70	2.05	1.09	71	1.30	83	0.005	290	290	22.1	0.0	270	63	62	64	63	60	-0.031		
197	31.510	31.884	0.16	0.16	1.34	70	2.06	1.09	71	1.30	83	0.005	290	290	22.1	0.0	269	63	62	64	63	60	-0.031		
198	31.669	32.044	0.16	0.16	1.34	70	2.04	1.09	71	1.30	83	0.006	265	263	22.1	0.0	264	63	62	64	63	60	-0.030		
199	31.828	32.205	0.16	0.16	1.33	70	2.06	1.09	71	1.30	83	0.005	290	290	22.1	0.0	261	63	62	64	63	59	-0.030		
200	31.987	32.366	0.16	0.16	1.34	70	2.06	1.09	71	1.30	83	0.005	290	290	22.0	-0.1	257	63	62	64	63	60	-0.029		
201	32.146	32.527	0.16	0.16	1.34	70	2.04	1.09	71	1.30	83	0.005	290	290	22.0	0.0	256	63	62	64	63	59	-0.030		
202	32.305	32.687	0.16	0.16	1.34	70	2.04	1.08	71	1.30	83	0.006	265	263	22.0	0.0	253	63	62	64	63	60	-0.029		
203	32.463	32.849	0.16	0.16	1.33	70	2.05	1.08	71	1.30	82	0.006	263	266	22.0	0.0	252	63	62	64	63	60	-0.028		
204	32.623	33.009	0.16	0.16	1.34	70	2.06	1.08	71	1.30	82	0.004	326	322	21.9	-0.1	251	63	61	64	63	60	-0.028		
205	32.782	33.169	0.16	0.16	1.34	70	2.05	1.09	71	1.30	83	0.005	290	288	21.9	0.0	251	63	61	64	63	60	-0.028		
206	32.941	33.330	0.16	0.16	1.33	70	2.05	1.09	71	1.30	82	0.006	265	265	21.9	0.0	249	64	61	64	63	60	-0.027		
207	33.100	33.491	0.16	0.16	1.32	70	2.07	1.08	71	1.40	76	0.047	94	94	21.9	0.0	246	63	61	64	63	59	-0.028		
208	33.258	33.652	0.16	0.16	1.33	70	2.06	1.08	71	1.40	73	0.042	99	99	21.8	-0.1	248	63	61	64	63	59	-0.028		
209	33.416	33.812	0.16	0.16	1.33	70	2.07	1.08	71	1.40	72	0.043	97	97	21.8	0.0	247	63	61	64	62	59	-0.028		
210	33.575	33.973	0.16	0.16	1.33	70	2.07	1.08	71	1.40	72	0.048	93	93	21.8	0.0	248	63	61	63	62	60	-0.028		
211	33.733	34.134	0.16	0.16	1.33	70	2.07	1.09	71	1.40	72	0.048	92	93	21.8	0.0	248	63	61	63	62	60	-0.028		
212	33.892	34.294	0.16	0.16	1.33	70	2.05	1.09	71	1.40	72	0.044	97	96	21.8	0.0	247	63	61	63	62	60	-0.027		
213	34.052	34.456	0.16	0.16	1.32	70	2.05	1.09	71	1.40	71	0.048	93	93	21.7	-0.1	247	63	61	63	62	59	-0.027		
214	34.210	34.616	0.16	0.16	1.33	70	2.05	1.08	71	1.40	71	0.044	96	96	21.7	0.0	245	63	61	63	62	60	-0.027		
215	34.369	34.776	0.16	0.16	1.33	70	2.05	1.09	71	1.40	71	0.047	94	93	21.7	0.0	244	63	61	63	62	60	-0.027		
216	34.527	34.937	0.16	0.16	1.33	70	2.07	1.09	71	1.40	71	0.044	96	97	21.7	0.0	244	62	61	63	62	59	-0.028		
217	34.685	35.098	0.16	0.16	1.33	70	2.05	1.08	71	1.40	71	0.045	95	96	21.6	-0.1	244	62	61	63	62	59	-0.027		
218	34.844	35.259	0.16	0.16	1.34	70	2.08	1.09	71	1.40	71	0.046	95	95	21.6	0.0	244	62	61	63	62	60	-0.027		
219	35.002	35.419	0.16	0.16	1.32	70	2.07	1.09	71	1.40	71	0.045	95	95	21.6	0.0	244	62	61	63	62	59	-0.027		
220	35.161	35.581	0.16	0.16	1.34	70	2.05	1.09	71	1.40	71	0.045	96	96	21.6	0.0	241	62	61	63	62	59	-0.027		
221	35.320	35.741	0.16	0.16	1.32	70	2.07	1.08	71	1.40	70	0.046	95	94	21.6	0.0	241	62	61	63	62	60	-0.027		
222	35.479	35.902	0.16	0.16	1.32	70	2.06	1.09	71	1.40	70	0.045	96	96	21.5	-0.1	240	62	61	63	62	60	-0.027		
223	35.637	36.063	0.16	0.16	1.33	70	2.06	1.09	71	1.40	70	0.050	90	91	21.5	0.0	238	62	61	63	62	60	-0.026		
224	35.795	36.224	0.16	0.16	1.33	70	2.08	1.08	71	1.40	70	0.043	97	98	21.5	0.0	237	62	61	63	62	60	-0.026		
225	35.954	36.384	0.16	0.16	1.33	70	2.08	1.09	71	1.40	70	0.045	96	95	21.5	0.0	238	62	61	62	62	60	-0.026		
226	36.112	36.545	0.16	0.16	1.33	70	2.08	1.09	71	1.40	70	0.046	94	95	21.5	0.0	235	62	61	62	62	60	-0.026		
227	36.271	36.706	0.16	0.16	1.33	70	2.06	1.09	71	1.40	70	0.047	94	94	21.4	-0.1	235	62	61	62	62	59	-0.026		
228	36.430	36.866	0.16	0.16	1.32	70	2.08	1.08	71	1.40	70	0.045	96	95	21.4	0.0	237	62	61	62	62	59	-0.027		
229	36.588	37.027	0.16	0.16	1.33	70	2.08	1.09	71	1.40	70	0.048	92	93	21.4	0.0	235	62	61	62	62	59	-0.025		
230	36.747	37.189	0.16	0.16	1.32	70	2.07	1.09	71	1.40	70	0.043	98	98	21.4	0.0	236	62	61	62	62	59	-0.026		
231	36.905	37.349	0.16	0.16	1.33	70	2.06	1.08	71	1.40	70	0.042	98	98	21.3	-0.1	237	62	61	62	62	60	-0.026		
232	37.064	37.509	0.16	0.16	1.32	70	2.08	1.09	71	1.40	70	0.045	96	95	21.3	0.0	235	62	61	62	62	60	-0.026		
233	37.222	37.671	0.16	0.16	1.33	70	2.08	1.09	71	1.40	70	0.047	93	94	21.3	0.0	235	62	61	62	62	60	-0.026		
234	37.380	37.831	0.16	0.16	1.33	70	2.08	1.09	71	1.40	70	0.046	94	94	21.3	0.0	228	62	61	62	62	59	-0.023		
235	37.539	37.992	0.16	0.16	1.33	70	2.07	1.09	71	1.40	69	0.045	95	96	21.3	0.0	219	62	61	62	62	60	-0.022		
236	37.698	38.152	0.16	0.16	1.32	70	2.07	1.09	71	1.40	69	0.050	91	90	21.3	0.0	210	62	61	62	62	60	-0.021		
237	37.856	38.314	0.16	0.16	1.32	70	2.06	1.09	71	1.40	68	0.047	93	94	21.3	0.0	202	62	61	62	62	60	-0.019		
238	38.015	38.474	0.16	0.16	1.32	70	2.08	1.09	71	1.40	68	0.045	95	95	21.3	0.0	194	62	61	62	62	60	-0.018		
239	38.173	38.635	0.16	0.16	1.33	70	2.06	1.09	71	1.40	67	0.046	94	94	21.3	0.0	186	61	61	62	62	60	-0.017		
240	38.331	38.797	0.16	0.16	1.32	70	2.08	1.09	71	1.40	67	0.047	93	94	21.3	0.0	179	61	61	62	61	60	-0.015		
241	38.490	38.957	0.16	0.16	1.33	70	2.08	1.08	71	1.40	67	0.046	94	94	21.3	0.0	173	61	60	62	61	60	-0.014		
242	38.648	39.117	0.16	0.16	1.33	70	2.08	1.09	71	1.40	66	0.046	94	94	21.3	0.0	167	61	60	61	61	59	-0.013		
243	38.808	39.278	0.16	0.16	1.33	70	2.08	1.09	71	1.40	66	0.048	93	92	21.3	0.0	161	61	60	61	61	59	-0.011		
244	38.967	39.440	0.16	0.16	1.33	70	2.07	1.08	71	1.40	65	0.046	94	95	21.3	0.0	155	61	60	61	61	59	-0.010		

### Pellet Heater Test Data - ASTM E2779 / ASTM E2515

Run: 1

Manufacturer: Hearth & Home High Burn End Time: 61  
 Model: PS35-C Medium Burn End Time: 182  
 Tracking No.: 2356 Total Sampling Time: 256 min  
 Project No.: 0061PS086E Recording Interval: 1 min  
 Test Date: 27-Feb-19  
 Beginning Clock Time: 10:21 Background Sample Volume: 0 cubic feet

Meter Box Y Factor: 1.022 (1) 0.995 (2) 0 (Amb)

Barometric Pressure: 

Begin	Middle	End	Average
<u>29.96</u>	<u>30.14</u>	<u>30.12</u>	<u>30.07</u>

 "Hg

PM Control Modules: 335, 336

Dilution Tunnel MW(dry): 29.00 lb/lb-mole  
 Dilution Tunnel MW(wet): 28.78 lb/lb-mole  
 Dilution Tunnel H2O: 2.00 percent  
 Dilution Tunnel Static: -0.180 "H<sub>2</sub>O  
 Tunnel Area: 0.1963 ft<sup>2</sup>  
 Pitot Tube Cp: 0.99

Avg. Tunnel Velocity: 12.63 ft/sec.  
 Initial Tunnel Flow: 146.4 scfm  
 Average Tunnel Flow: 141.7 scfm  
 Post-Test Leak Check (1): 0.000 cfm @ 7 in. Hg  
 Post-Test Leak Check (2): 0.000 cfm @ 9 in. Hg  
 Fuel Moisture (%): 5.966 Dry Basis 5.630 Wet Basis

Velocity Traverse Data									
	Pt.1	Pt.2	Pt.3	Pt.4	Pt.5	Pt.6	Pt.7	Pt.8	Center
Initial dP	<u>0.037</u>	<u>0.042</u>	<u>0.046</u>	<u>0.032</u>	<u>0.031</u>	<u>0.041</u>	<u>0.045</u>	<u>0.039</u>	<u>0.047</u>
Temp:	<u>107</u>	<u>107</u>	<u>107</u>	<u>107</u>	<u>106</u>	<u>107</u>	<u>107</u>	<u>107</u>	<u>107</u>
	V <sub>strav</sub> <u>13.55</u> ft/sec			V <sub>scent</sub> <u>14.88</u> ft/sec			F <sub>p</sub> <u>0.910</u>		

Elapsed Time (min)	Particulate Sampling Data												Fuel Weight (lb)		Temperature Data (°F)						Stack Gas Data				
	Gas Meter 1 (ft <sup>3</sup> )	Gas Meter 2 (ft <sup>3</sup> )	Sample Rate 1 (cfm)	Sample Rate 2 (cfm)	Orifice dH 1 ("H <sub>2</sub> O)	Meter Temp 1 (°F)	Meter Vacuum 1 ("Hg)	Orifice dH 2 ("H <sub>2</sub> O)	Meter Temp 2 (°F)	Meter Vacuum 2 ("Hg)	Dilution Tunnel (°F)	Tunnel Center dP	Pro. Rate 1	Pro. Rate 2	Scale Reading	Weight Change	Stack	Filter 1	Dryer 1	Filter 2	Dryer 2	Ambient	Draft ("H <sub>2</sub> O)	CO <sub>2</sub> (%)	CO (%)
245	39.125	39.600	0.16	0.16	1.33	70	2.06	1.08	71	1.40	65	0.047	92	93	21.3	0.0	150	61	60	61	61	60	-0.009		
246	39.284	39.761	0.16	0.16	1.32	70	2.08	1.09	71	1.40	64	0.047	93	93	21.3	0.0	145	61	60	61	61	59	-0.008		
247	39.442	39.923	0.16	0.16	1.33	70	2.08	1.09	71	1.40	64	0.046	93	95	21.3	0.0	140	61	60	61	61	59	-0.007		
248	39.600	40.083	0.16	0.16	1.34	70	2.07	1.08	71	1.40	64	0.045	94	94	21.3	0.0	136	61	60	61	61	59	-0.007		
249	39.759	40.244	0.16	0.16	1.33	70	2.07	1.09	71	1.40	64	0.043	97	97	21.3	0.0	132	61	60	61	61	59	-0.006		
250	39.918	40.405	0.16	0.16	1.33	70	2.08	1.09	71	1.40	63	0.048	92	92	21.3	0.0	128	61	60	61	61	59	-0.005		
251	40.077	40.566	0.16	0.16	1.33	70	2.06	1.09	71	1.40	63	0.046	94	94	21.3	0.0	124	61	60	61	61	59	-0.004		
252	40.236	40.727	0.16	0.16	1.33	70	2.08	1.09	71	1.40	63	0.047	93	93	21.3	0.0	122	61	60	61	61	59	-0.003		
253	40.395	40.887	0.16	0.16	1.33	70	2.08	1.09	71	1.40	62	0.044	96	95	21.3	0.0	119	61	60	61	61	59	-0.002		
254	40.553	41.049	0.16	0.16	1.33	70	2.08	1.09	71	1.40	62	0.047	92	93	21.3	0.0	117	61	60	61	61	59	-0.002		
255	40.712	41.209	0.16	0.16	1.33	70	2.07	1.09	71	1.40	62	0.048	92	91	21.3	0.0	115	61	60	61	61	59	-0.001		
256	40.870	41.370	0.16	0.16	1.33	70	2.06	1.09	71	1.40	62	0.046	93	94	21.3	0.0	114	60	60	61	61	59	-0.001		

## Pellet Heater Lab Data - ASTM E2779 / ASTM E2515

Manufacturer: Hearth & Home      Equipment Numbers: 283A, 592, 637  
 Model: PS35-C  
 Tracking No.: 2356  
 Project No.: 0061PS086E  
 Run #: 1      Technician Signature: \_\_\_\_\_  
 Date: 2/27/19

### TRAIN 1 (First Hour emissions)

Sample Component	Reagent	Filter, Probe or Seal #	Mass Readings		
			Tare, mg	Final, mg	Particulate, mg
A. Front filter catch	Filter	D681	121.4		-121.4
B. Rear filter catch	Filter				0.0
C. Probe catch*	Probe				0.0
D. Filter seals catch*	Seals				0.0
1 <sup>st</sup> hour Sub-Total, mg:					-121.4

### TRAIN 1 (Remainder of Test)

Sample Component	Reagent	Filter, Probe or Seal #	Mass Readings		
			Tare, mg	Final, mg	Particulate, mg
A. Front filter catch	Filter	D682	121.2		-121.2
B. Rear filter catch	Filter	D683	121.0		-121.0
C. Probe catch*	Probe	9	115691.9		0.0
D. Filter seals catch*	Seals	R739	3546.5		0.0
Remainder Sub-Total, mg:					-242.2
Train 1 Aggregate, mg:					-363.6

### TRAIN 2

Sample Component	Reagent	Filter, Probe or Seal #	Mass Readings		
			Tare, mg	Final, mg	Particulate, mg
A. Front filter catch	Filter	D684	120.1		-120.1
B. Rear filter catch	Filter	D685	122.2		-122.2
C. Probe catch*	Probe	11.0	114183.7		0.0
D. Filter seals catch*	Seals	R748	3549.2		0.0
Train 2 Aggregate, mg:					-242.3

### AMBIENT

Sample Component	Reagent	Filter, Probe or Seal #	Mass Readings		
			Tare, mg	Final, mg	Particulate, mg
A. Front filter catch*	Filter				0.0
Ambient Aggregate, mg:					0.0

\*Particulate catch that results in a negative number, is assumed to be zero for probes and seals, negative numbers for filters are assumed to be included in O-ring seal weights.

Pellet Heater Certification Run Sheets

Client: HHT Project Number: 0061PS086E Run Number: 1  
 Model: PS35-C Tracking Number: 2356 Date: 2/27/14  
 Test Crew: A. Krawitz  
 OMNI Equipment ID numbers: \_\_\_\_\_

ASTM E2779 Run Notes

Air Control Settings

High Burn Rate Target: 100%

Settings: Rocker switch high  
FRAP rod out  
Control board 3

Medium Burn Rate Target: <50%

Settings: Rocker switch med  
FRAP rod in  
Control board 2

Low Burn Rate Target: Minimum

Settings: Rocker switch low  
FRAP rod in  
Control board 2

Additional Settings Notes:

Pellet Moisture Content: 5.63% WB

Pellet Specifications: Somerset Hard wood

Pellet Analysis Notes: W218-1106-01

Preburn Notes

Time	Notes

Test Notes

Time	Notes
60:00	Changes filter A
61:00	set unit to med
162:00	set to low
256:00	RUN ABORTED

Technician Signature: 

Date: \_\_\_\_\_



### Pellet Heater Certification Run Sheets

Client: HHT Project Number: 0061PS086E Run Number: 1  
 Model: PS35-C Tracking Number: \_\_\_\_\_ Date: \_\_\_\_\_  
 Test Crew: \_\_\_\_\_  
 OMNI Equipment ID numbers: \_\_\_\_\_

#### ASTM E2515 Sampling Information

Test Location: \_\_\_\_\_ Clock Time @ ET=0: \_\_\_\_\_

Span Gas Concentrations: CO<sub>2</sub>(%): 17.01 CO(%): 4.240 CO(ppm): 901

Test Run Validation Checks	Pre Test	Post Test
Zero Stack Gas Leakage	/	
Zero Pitot Line Leakage	✓	
Zero Induced Draft	✓	
100% Smoke Capture	/	

Test Run Validation Measurements	Pre Test		Post Test	
Scale Audit (lbs)	10.0			
CO <sub>2</sub> % (Zero/Span)	0.06	17.06		
CO % (Zero/Span)	0.000	4.240		
CO ppm (Zero/Span)	0			
Sample A Leakage (cfm @”Hg)	0		@	
Sample B Leakage (cfm @”Hg)	0		@	
Room Air Velocity (ft/min)	<50			
Barometric Pressure (“Hg)	29.96			
Relative Humidity (%)				
Tunnel Static (“H <sub>2</sub> O)	-0.18			

#### Last Cleaning Dates

Flue Pipe	Brand New!
Dilution Tunnel	01/20/10
Sample Dryers	2/27/19

#### Dilution Tunnel Traverse

Traverse Point	1	2	Center	3	4	5	6	7	8
Δp (“H <sub>2</sub> O)	0.037	0.042	0.047	0.046	0.032	0.031	0.041	0.045	0.039
T (°F)	107	107	107	107	107	106	107	→	

Technician Signature: \_\_\_\_\_

Date: \_\_\_\_\_

### Pellet Heater Certification Run Sheets

Client: HHT Project Number: 0061PS086E Run Number: 1  
 Model: PS35-C Tracking Number: \_\_\_\_\_ Date: \_\_\_\_\_  
 Test Crew: \_\_\_\_\_  
 OMNI Equipment ID numbers: \_\_\_\_\_

#### ASTM E2515 Lab Sheet

Assembled By:

*A. Krawitz*

Date/Time in Desiccator:

Weighing #1	Weighing #2	Weighing #3	Weighing #4
Date:	Date:	Date:	Date:
Time:	Time:	Time:	Time:
R/H %:	R/H %:	R/H %:	R/H %:
Temp (F):	Temp (F):	Temp (F):	Temp (F):
Audit 1:	Audit 1:	Audit 1:	Audit 1:
Audit 2:	Audit 2:	Audit 2:	Audit 2:
Audit 3:	Audit 3:	Audit 3:	Audit 3:
Initials:	Initials:	Initials:	Initials:

Train	Item	ID #	Tare (mg)	Weight (mg)	Weight (mg)	Weight (mg)	Weight (mg)
A	Front Filter (60 min)	D681	121.4				
A	Front Filter (Remainder)	D682	121.2				
A	Rear Filter	D683	121.0				
A	Probe	9	115691.9				
A	O-Ring Set	R739	3546.5				
B	Front Filter	D684	120.1				
B	Rear Filter	D685	122.2				
B	Probe	11	114183.7				
B	O-Ring Set	R748	3549.2				
BG	Filter						

Technician Signature: \_\_\_\_\_

*[Handwritten Signature]*

Date: \_\_\_\_\_

## **2.1 - Test Data by Run**

Run 2 Notes & Results

## ASTM E2779 / ASTM E2515 Emissions Results

Manufacturer: Hearth & Home  
 Model: PS35-C  
 Project No.: 0061PS086E  
 Tracking No.: 2356  
 Run: 2  
 Test Date: 02/28/19

Technician Signature: 

Integrated Test Run	
Particulate Emission Rate	<b>1.02 g/hr</b>
Total Particulate Emissions - $E_T$	6.15 g
Emissions Factor	0.96 g/kg
CSA B415 Efficiency	<b>68.8% HHV</b>

First Hour Emissions	
Particulate Emission Rate	2.04 g/hr
Total Particulate Emissions - $E_T$	2.04 g
Emissions Factor	0.92 g/kg

Burn Rate (Composite)	<b>1.06 kg/hr dry</b>	
Burn Rate (High)	2.23 kg/hr dry	
Burn Rate (Medium)	1.04 kg/hr dry	46.6% Of High
Burn Rate (Low)	0.67 kg/hr dry	30.1% Of High
Average Tunnel Temperature	91 degrees F	
Avg. Velocity in Dilution Tunnel - $v_s$	12.92 ft/second	
Avg. Flow Rate in Dilution Tunnel - $Q_{sd}$	8646.3 dscf/hour	
Average $\Delta p$	0.047 inches H2O	
Average $\Delta H$	1.32 inches H2O	
Total Time of Test	362 minutes	

## ASTM E2779 / ASTM E2515 Emissions Results

Manufacturer: Hearth & Home  
 Model: PS35-C  
 Project No.: 0061PS086E  
 Tracking No.: 2356  
 Run: 2  
 Test Date: 02/28/19

Technician Signature: 

	1 <sup>st</sup> Hour	Sample Train 1	Sample Train 2	Sample	Unit
Total Sample Volume - $V_m$	9.494	57.531	57.726	N/A	ft <sup>3</sup>
Average Gas Meter Temperature	72.89	77.90	78.05		°F
Sample Volume (Std. Conditions) - $V_{mstd}$	9.731	58.419	57.017		dsf <sup>3</sup>
Total Particulates - $m_n$	2.3	6.8	6.8		mg
Particulate Concentration - $C_r/C_s$	2.363E-04	1.16E-04	1.19E-04		g/dsf <sup>3</sup>
Total Particulate Emissions - $E_T$	2.04	6.07	6.22		g
Particulate Emission Rate	2.04	1.01	1.03		g/hr
Emissions Factor	0.92	0.95	0.98		g/kg
Delta from Avg. Particulate Emissions		0.07	0.07		g

Quality Checks			
Filter Temps < 90 °F	OK	Ambient Temp (55-90°F)	OK
Filter Face Velocity	OK	Negative Probe Weight	OK
Leakage Rate	OK	Pro-Rate Variation	OK
Medium Burn Rate < 50%	OK	Dual Train Comparison	OK

### CSA B415.1 Results - Overall & By Category

Manufacturer: Hearth & Home  
 Model: PS35-C  
 Date: 02/28/19

Run: 2  
 Control #: 0061PS086E  
 Test Duration: 362

Test Results in Accordance with CSA B415.1-09 - Overall			
	HHV Basis	LHV Basis	
Overall Efficiency	68.8%	73.6%	
Combustion Efficiency	99.5%	99.5%	
Heat Transfer Efficiency	69%	73.9%	
Output Rate (kJ/h)	14,407	13,667	(Btu/h)
Burn Rate (kg/h)	1.06	2.33	(lb/h)
Input (kJ/h)	20,940	19,864	(Btu/h)
Test Load Weight (dry kg)	6.38	14.06	dry lb
MC wet (%)	5.63		
MC dry (%)	5.97		
Particulate (g )	6.15		
CO (g)	53		
Test Duration (h)	6.03		
Emissions	Particulate	CO	
g/MJ Output	0.07	0.61	
g/kg Dry Fuel	0.96	8.26	
g/h	1.02	8.74	
lb/MM Btu Output	0.16	1.41	
Air/Fuel Ratio (A/F)	28.61		

Test Results in Accordance with CSA B415.1-09 - Maximum			
	HHV Basis	LHV Basis	
Overall Efficiency	70.8%	75.7%	
Combustion Efficiency	99.5%	99.5%	
Heat Transfer Efficiency	71%	76.1%	
Output Rate (kJ/h)	31,288	29,680	(Btu/h)
Burn Rate (kg/h)	2.23	4.92	(lb/h)
Input (kJ/h)	44,203	41,931	(Btu/h)
Test Load Weight (dry kg)	2.27	5.00	dry lb
MC wet (%)	5.63		
MC dry (%)	5.97		
Particulate (g )	2.30		
CO (g)	3		
Test Duration (h)	1.02		
Emissions	Particulate	CO	
g/MJ Output	0.07	0.08	
g/kg Dry Fuel	1.01	1.11	
g/h	2.26	2.47	
lb/MM Btu Output	0.17	0.18	
Air/Fuel Ratio (A/F)	15.92		

Test Results in Accordance with CSA B415.1-09 - Medium			
	HHV Basis	LHV Basis	
Overall Efficiency	66.2%	70.8%	
Combustion Efficiency	99.5%	71.1%	
Heat Transfer Efficiency	67%	71.1%	
Output Rate (kJ/h)	13,639	12,938	(Btu/h)
Burn Rate (kg/h)	1.04	2.29	(lb/h)
Input (kJ/h)	20,602	19,543	(Btu/h)
Test Load Weight (dry kg)	2.10	4.62	dry lb
MC wet (%)	5.63		
MC dry (%)	5.97		
Particulate (g )	-		
CO (g)	18		
Test Duration (h)	2.02		
Emissions	Particulate	CO	
g/MJ Output	-	0.66	
g/kg Dry Fuel	-	8.66	
g/h	-	9.01	
lb/MM Btu Output	-	1.54	
Air/Fuel Ratio (A/F)	29.58		

Test Results in Accordance with CSA B415.1-09 - Minimum			
	HHV Basis	LHV Basis	
Overall Efficiency	68.6%	73.4%	
Combustion Efficiency	99.5%	73.7%	
Heat Transfer Efficiency	69%	73.7%	
Output Rate (kJ/h)	9,117	8,649	(Btu/h)
Burn Rate (kg/h)	0.67	1.48	(lb/h)
Input (kJ/h)	13,284	12,601	(Btu/h)
Test Load Weight (dry kg)	2.01	4.44	dry lb
MC wet (%)	5.63		
MC dry (%)	5.97		
Particulate (g )	-		
CO (g)	31		
Test Duration (h)	3.00		
Emissions	Particulate	CO	
g/MJ Output	-	1.15	
g/kg Dry Fuel	-	15.56	
g/h	-	10.44	
lb/MM Btu Output	-	2.66	
Air/Fuel Ratio (A/F)	37.99		

VERSION: 2-2 42/14/2009

Modified to fit this Format

## Pellet Heater Preburn Data - ASTM E2779

Manufacturer: Hearth & Home  
 Model: PS35-C  
 Tracking No.: 2356  
 Project No.: 0061PS086E  
 Test Date: 2/28/2019

PB Length: 60 min  
 Recording Interval: 10 min

Averages: 

472	68	-0.05		
-----	----	-------	--	--

Elapsed Time (min)	Scale Reading	Weight Change	Stack (F)	Ambient (F)	Draft ("H2O)	CO2 (%)	CO (%)
0	52.5	-	441	66	-0.04		
10	48.5	-4	451	67	-0.04		
20	47.4	-1.1	471	67	-0.05		
30	46.3	-1.1	477	68	-0.05		
40	45.2	-1.1	483	68	-0.05		
50	44.1	-1.1	489	70	-0.05		
60	42.9	-1.2	491	72	-0.05		

Pellet Heater Test Data - ASTM E2779 / ASTM E2515

Run: 2  
 Manufacturer: Hearth & Home High Burn End Time: 61  
 Model: PS35-C Medium Burn End Time: 182  
 Tracking No.: 2356 Total Sampling Time: 362 min  
 Project No.: 0061PS086E Recording Interval: 1 min  
 Test Date: 28-Feb-19  
 Beginning Clock Time: 10:21 Background Sample Volume: 0 cubic feet  
 Meter Box Y Factor: 1.022 (1) 0.995 (2) 0 (Amb)  
 Barometric Pressure: Begin Middle End Average  
30.26 30.20 30.14 30.20 "Hg

PM Control Modules: 335, 336  
 Dilution Tunnel MW(dry): 29.00 lb/lb-mole  
 Dilution Tunnel MW(wet): 28.78 lb/lb-mole  
 Dilution Tunnel H2O: 2.00 percent  
 Dilution Tunnel Static: -0.190 "H<sub>2</sub>O  
 Tunnel Area: 0.1963 ft<sup>2</sup>  
 Pitot Tube Cp: 0.99  
 Avg. Tunnel Velocity: 12.92 ft/sec.  
 Initial Tunnel Flow: 141.3 scfm  
 Average Tunnel Flow: 144.1 scfm  
 Post-Test Leak Check (1): 0.000 cfm @ 7 in. Hg  
 Post-Test Leak Check (2): 0.000 cfm @ 9 in. Hg  
 Fuel Moisture (%): 5.966 Dry Basis 5.630 Wet Basis

	Pt.1	Pt.2	Pt.3	Pt.4	Pt.5	Pt.6	Pt.7	Pt.8	Center
Initial dP	0.028	0.042	0.046	0.040	0.026	0.038	0.042	0.032	0.047
Temp:	108	108	108	108	108	108	108	108	108
	V <sub>strav</sub> 13.05 ft/sec			V <sub>scent</sub> 14.82 ft/sec			F <sub>p</sub> 0.880		

Elapsed Time (min)	Particulate Sampling Data											Fuel Weight (lb)		Temperature Data (°F)						Stack Gas Data					
	Gas Meter 1 (ft <sup>3</sup> )	Gas Meter 2 (ft <sup>3</sup> )	Sample Rate 1 (cfm)	Sample Rate 2 (cfm)	Orifice dH 1 ("H <sub>2</sub> O)	Meter Temp 1 (°F)	Meter Vacuum 1 ("Hg)	Orifice dH 2 ("H <sub>2</sub> O)	Meter Temp 2 (°F)	Meter Vacuum 2 ("Hg)	Dilution Tunnel (°F)	Tunnel Center dP	Pro. Rate 1	Pro. Rate 2	Scale Reading	Weight Change	Stack	Filter 1	Dryer 1	Filter 2	Dryer 2	Ambient	Draft ("H <sub>2</sub> O)	CO <sub>2</sub> (%)	CO (%)
0	0.000	0.000			1.07	69	1.69	0.08	69	1.50	108	0.049			36.6		491	67	68	68	69	68	-0.049	8.44	0.004
1	0.147	0.153	0.15	0.15	1.36	69	1.75	1.05	69	1.50	108	0.047	96	99	36.5	-0.1	488	68	68	69	70	67	-0.048	7.35	0.006
2	0.306	0.310	0.16	0.16	1.35	69	1.76	1.05	69	1.40	109	0.049	102	100	36.4	-0.1	488	69	69	69	70	68	-0.048	7.87	0.007
3	0.465	0.466	0.16	0.16	1.35	69	1.76	1.05	69	1.50	109	0.048	103	100	36.4	0.0	483	69	69	70	70	67	-0.049	5.93	0.018
4	0.624	0.628	0.16	0.16	1.36	69	1.75	1.12	69	1.60	109	0.046	105	107	36.3	-0.1	483	70	69	70	70	67	-0.048	6.79	0.012
5	0.783	0.789	0.16	0.16	1.35	69	1.76	1.11	69	1.60	108	0.046	105	106	36.2	-0.1	485	70	69	70	70	67	-0.049	7.92	0.004
6	0.941	0.949	0.16	0.16	1.34	69	1.75	1.13	70	1.60	109	0.047	103	104	36.1	-0.1	488	70	69	71	70	67	-0.050	8.48	0.004
7	1.099	1.105	0.16	0.16	1.34	69	1.75	1.08	70	1.50	109	0.049	101	99	36.0	-0.1	490	70	69	71	71	66	-0.050	7.88	0.005
8	1.257	1.263	0.16	0.16	1.33	69	1.75	1.08	70	1.50	109	0.046	104	104	35.9	-0.1	487	71	69	71	71	66	-0.049	6.69	0.007
9	1.414	1.421	0.16	0.16	1.34	70	1.75	1.08	70	1.50	109	0.047	102	103	35.8	-0.1	487	71	69	71	71	67	-0.050	6.69	0.011
10	1.573	1.580	0.16	0.16	1.34	70	1.75	1.07	70	1.50	108	0.047	103	103	35.8	0.0	488	71	69	71	71	67	-0.049	7.72	0.007
11	1.731	1.738	0.16	0.16	1.34	70	1.74	1.08	70	1.50	108	0.047	103	103	35.7	-0.1	485	71	69	72	71	68	-0.049	6.34	0.012
12	1.889	1.898	0.16	0.16	1.34	70	1.74	1.08	70	1.50	109	0.046	104	105	35.6	-0.1	485	71	69	72	71	67	-0.049	7.31	0.008
13	2.047	2.055	0.16	0.16	1.32	70	1.74	1.07	71	1.50	108	0.046	104	103	35.5	-0.1	484	72	69	72	71	67	-0.049	7.53	0.007
14	2.204	2.214	0.16	0.16	1.33	70	1.74	1.07	71	1.50	109	0.047	102	103	35.4	-0.1	487	72	69	72	71	67	-0.049	8.61	0.006
15	2.361	2.372	0.16	0.16	1.33	71	1.74	1.06	71	1.50	109	0.047	102	102	35.3	-0.1	487	72	69	72	71	66	-0.049	8.23	0.005
16	2.519	2.530	0.16	0.16	1.32	71	1.74	1.06	71	1.50	109	0.046	104	104	35.3	0.0	486	72	69	72	71	67	-0.049	6.63	0.015
17	2.677	2.689	0.16	0.16	1.33	71	1.74	1.06	71	1.50	109	0.045	105	105	35.2	-0.1	485	72	69	72	71	67	-0.048	7.27	0.006
18	2.835	2.846	0.16	0.16	1.32	71	1.74	1.06	71	1.50	109	0.047	103	102	35.1	-0.1	483	72	69	73	71	66	-0.048	6.45	0.008
19	2.992	3.004	0.16	0.16	1.32	71	1.73	1.06	72	1.50	109	0.047	102	102	35.0	-0.1	483	73	69	73	71	67	-0.049	7.29	0.008
20	3.149	3.163	0.16	0.16	1.32	72	1.74	1.06	72	1.50	108	0.048	101	102	34.9	-0.1	485	73	70	73	72	67	-0.049	7.79	0.005
21	3.307	3.320	0.16	0.16	1.32	72	1.74	1.06	72	1.50	108	0.046	104	103	34.8	-0.1	484	73	70	73	72	67	-0.049	6.21	0.015
22	3.464	3.479	0.16	0.16	1.32	72	1.74	1.06	72	1.50	109	0.046	103	104	34.7	-0.1	486	73	70	73	72	68	-0.049	7.52	0.006
23	3.624	3.636	0.16	0.16	1.34	72	1.76	1.06	72	1.50	108	0.049	102	99	34.7	0.0	488	73	70	73	72	67	-0.049	9.09	0.003
24	3.783	3.794	0.16	0.16	1.33	72	1.76	1.06	72	1.50	109	0.047	103	102	34.6	-0.1	487	73	70	73	72	67	-0.049	7.34	0.008
25	3.941	3.952	0.16	0.16	1.33	72	1.76	1.06	73	1.50	109	0.047	103	102	34.5	-0.1	489	73	70	73	72	66	-0.050	7.64	0.005
26	4.099	4.110	0.16	0.16	1.34	73	1.76	1.06	73	1.50	109	0.048	101	101	34.4	-0.1	489	73	70	73	72	66	-0.049	8.10	0.004
27	4.257	4.268	0.16	0.16	1.33	73	1.76	1.06	73	1.50	109	0.045	105	104	34.3	-0.1	490	73	70	73	72	66	-0.050	8.39	0.005
28	4.415	4.426	0.16	0.16	1.33	73	1.76	1.06	73	1.50	109	0.047	102	102	34.2	-0.1	492	73	70	73	72	66	-0.050	7.87	0.007
29	4.574	4.584	0.16	0.16	1.34	73	1.77	1.06	73	1.50	109	0.046	104	103	34.1	-0.1	493	73	70	73	72	66	-0.049	7.83	0.005
30	4.733	4.742	0.16	0.16	1.33	73	1.77	1.06	73	1.50	109	0.047	103	102	34.0	-0.1	493	73	70	73	72	66	-0.049	7.38	0.008
31	4.892	4.899	0.16	0.16	1.34	73	1.76	1.06	74	1.50	109	0.046	104	102	34.0	0.0	492	74	70	73	72	66	-0.050	7.52	0.006
32	5.050	5.058	0.16	0.16	1.33	73	1.77	1.05	74	1.50	109	0.046	103	104	33.9	-0.1	495	74	70	74	72	66	-0.049	8.17	0.006
33	5.209	5.216	0.16	0.16	1.32	74	1.77	1.06	74	1.50	109	0.048	102	101	33.8	-0.1	494	74	70	74	72	66	-0.051	7.24	0.008
34	5.367	5.375	0.16	0.16	1.33	74	1.77	1.06	74	1.50	109	0.048	101	101	33.7	-0.1	497	74	70	74	72	66	-0.050	7.92	0.006
35	5.526	5.532	0.16	0.16	1.33	74	1.77	1.06	74	1.50	109	0.047	103	101	33.6	-0.1	494	74	70	74	73	67	-0.049	7.90	0.005
36	5.684	5.690	0.16	0.16	1.34	74	1.77	1.06	74	1.50	109	0.047	102	102	33.5	-0.1	492	74	70	74	73	67	-0.050	7.14	0.009
37	5.843	5.848	0.16	0.16	1.33	74	1.77	1.05	75	1.50	110	0.046	104	103	33.4	-0.1	492	74	70	74	73	68	-0.050	6.56	0.012
38	6.002	6.006	0.16	0.16	1.33	74	1.77	1.06	75	1.50	110	0.047	103	102	33.3	-0.1	495	74	70	74	73	67	-0.051	8.36	0.004
39	6.161	6.165	0.16	0.16	1.33	74	1.77	1.06	75	1.50	110	0.046	104	103	33.2	-0.1	496	74	71	74	73	67	-0.049	8.41	0.006
40	6.320	6.322	0.16	0.16	1.33	75	1.77	1.06	75	1.50	110	0.045	105	103	33.1	-0.1	497	74	71	74	73	67	-0.050	8.06	0.006
41	6.478	6.480	0.16	0.16	1.33	75	1.77	1.06	75	1.60	110	0.048	101	101	33.1	0.0	497	74	71	74	73	66	-0.050	8.49	0.005
42	6.636	6.639	0.16	0.16	1.33	75	1.77	1.05	75	1.50	110	0.048	101	101	33.0	-0.1	498	74	71	74	73	67	-0.050	7.76	0.008
43	6.795	6.796	0.16	0.16	1.33	75	1.77	1.06	75	1.50	110	0.047	103	101	32.9	-0.1	496	74	71	74	73	66	-0.049	8.43	0.005
44	6.953	6.955	0.16	0.16	1.33	75	1.77	1.06	76	1.50	110	0.046	103	103	32.8	-0.1	494	74	71	74	73	66	-0.050	6.69	0.013
45	7.112	7.113	0.16	0.16	1.34	75	1.77	1.05	76	1.60	110	0.046	104	103	32.7	-0.1	492	74	71	74	73	67	-0.050	7.06	0.007
46	7.271	7.271	0.16	0.16	1.34	75	1.77	1.06	76	1.60	110	0.048	102	100	32.6	-0.1	491	74	71	74	73	67	-0.050	7.18	0.009
47	7.431	7.429	0.16	0.16	1.33	75	1.78	1.06	76	1.60	109	0.046	104	103	32.6	0.0	490	74	71	74	73	67	-0.049	7.02	0.006
48	7.589	7.587	0.16	0.1																					



### Pellet Heater Test Data - ASTM E2779 / ASTM E2515

Run: 2

Manufacturer: Hearth & Home High Burn End Time: 61  
 Model: PS35-C Medium Burn End Time: 182  
 Tracking No.: 2356 Total Sampling Time: 362 min  
 Project No.: 0061PS086E Recording Interval: 1 min  
 Test Date: 28-Feb-19  
 Beginning Clock Time: 10:21 Background Sample Volume: 0 cubic feet

Meter Box Y Factor: 1.022 (1) 0.995 (2) 0 (Amb)

Barometric Pressure: Begin Middle End Average  
30.26 30.20 30.14 30.20 "Hg

PM Control Modules: 335, 336

Dilution Tunnel MW(dry): 29.00 lb/lb-mole  
 Dilution Tunnel MW(wet): 28.78 lb/lb-mole  
 Dilution Tunnel H2O: 2.00 percent  
 Dilution Tunnel Static: -0.190 "H<sub>2</sub>O  
 Tunnel Area: 0.1963 ft<sup>2</sup>  
 Pitot Tube Cp: 0.99

Avg. Tunnel Velocity: 12.92 ft/sec.  
 Initial Tunnel Flow: 141.3 scfm  
 Average Tunnel Flow: 144.1 scfm  
 Post-Test Leak Check (1): 0.000 cfm @ 7 in. Hg  
 Post-Test Leak Check (2): 0.000 cfm @ 9 in. Hg  
 Fuel Moisture (%): 5.966 Dry Basis 5.630 Wet Basis

Velocity Traverse Data									
	Pt.1	Pt.2	Pt.3	Pt.4	Pt.5	Pt.6	Pt.7	Pt.8	Center
Initial dP	<u>0.028</u>	<u>0.042</u>	<u>0.046</u>	<u>0.040</u>	<u>0.026</u>	<u>0.038</u>	<u>0.042</u>	<u>0.032</u>	<u>0.047</u>
Temp:	<u>108</u>	<u>108</u>	<u>108</u>	<u>108</u>	<u>108</u>	<u>108</u>	<u>108</u>	<u>108</u>	<u>108</u>
V <sub>strav</sub>	<u>13.05</u> ft/sec			V <sub>scent</sub>			<u>14.82</u> ft/sec		
F <sub>p</sub>	<u>0.880</u>								

Elapsed Time (min)	Particulate Sampling Data											Fuel Weight (lb)		Temperature Data (°F)						Stack Gas Data					
	Gas Meter 1 (ft <sup>3</sup> )	Gas Meter 2 (ft <sup>3</sup> )	Sample Rate 1 (cfm)	Sample Rate 2 (cfm)	Orifice dH 1 ("H <sub>2</sub> O)	Meter Temp 1 (°F)	Meter Vacuum 1 ("Hg)	Orifice dH 2 ("H <sub>2</sub> O)	Meter Temp 2 (°F)	Meter Vacuum 2 ("Hg)	Dilution Tunnel (°F)	Tunnel Center dP	Pro. Rate 1	Pro. Rate 2	Scale Reading	Weight Change	Stack	Filter 1	Dryer 1	Filter 2	Dryer 2	Ambient	Draft ("H <sub>2</sub> O)	CO <sub>2</sub> (%)	CO (%)
49	7.748	7.746	0.16	0.16	1.33	76	1.78	1.06	76	1.60	110	0.047	102	102	32.4	-0.1	490	74	71	74	73	67	-0.049	6.99	0.014
50	7.906	7.904	0.16	0.16	1.33	76	1.78	1.06	76	1.60	109	0.046	103	103	32.3	-0.1	494	74	71	74	73	67	-0.050	9.24	0.004
51	8.065	8.062	0.16	0.16	1.33	76	1.77	1.06	76	1.60	110	0.048	101	100	32.2	-0.1	497	74	71	74	73	67	-0.052	8.65	0.004
52	8.223	8.221	0.16	0.16	1.33	76	1.78	1.06	77	1.60	110	0.047	102	102	32.1	-0.1	500	74	71	74	73	67	-0.051	8.76	0.004
53	8.382	8.379	0.16	0.16	1.33	76	1.77	1.06	77	1.60	110	0.047	102	101	32.0	-0.1	500	74	71	74	73	67	-0.051	8.96	0.004
54	8.541	8.538	0.16	0.16	1.33	76	1.78	1.06	77	1.60	110	0.046	104	103	31.9	-0.1	498	74	71	74	73	67	-0.050	8.05	0.004
55	8.701	8.695	0.16	0.16	1.33	76	1.78	1.06	77	1.60	110	0.047	103	101	31.8	-0.1	498	75	71	75	73	68	-0.050	6.90	0.010
56	8.860	8.854	0.16	0.16	1.33	76	1.78	1.06	77	1.60	110	0.046	104	103	31.7	-0.1	500	75	71	75	73	67	-0.051	8.58	0.005
57	9.018	9.012	0.16	0.16	1.32	76	1.78	1.06	77	1.60	110	0.049	100	99	31.6	-0.1	500	75	71	75	73	67	-0.051	8.26	0.005
58	9.177	9.170	0.16	0.16	1.33	76	1.78	1.06	77	1.60	110	0.046	104	102	31.6	0.0	501	75	71	75	73	67	-0.052	7.82	0.006
59	9.335	9.329	0.16	0.16	1.32	76	1.78	1.06	77	1.60	110	0.047	102	102	31.5	-0.1	500	75	71	75	74	67	-0.050	8.44	0.004
60	9.494	9.487	0.16	0.16	1.33	77	1.79	1.06	77	1.60	110	0.045	105	104	31.4	-0.1	502	75	71	75	74	68	-0.051	7.77	0.007
61	9.655	9.646	0.16	0.16	1.34	77	1.76	1.06	77	1.60	110	0.046	105	103	31.3	-0.1	499	74	70	75	74	67	-0.054	8.52	0.005
62	9.815	9.804	0.16	0.16	1.34	77	1.76	1.05	77	1.60	109	0.045	105	103	31.2	-0.1	491	74	71	75	74	67	-0.049	8.04	0.006
63	9.975	9.963	0.16	0.16	1.34	77	1.75	1.06	77	1.60	110	0.046	104	103	31.2	0.0	494	75	71	75	74	68	-0.051	6.26	0.039
64	10.135	10.122	0.16	0.16	1.34	77	1.76	1.06	77	1.60	110	0.046	104	103	31.1	-0.1	498	75	71	75	74	67	-0.051	6.38	0.019
65	10.295	10.280	0.16	0.16	1.35	77	1.76	1.06	78	1.60	111	0.047	103	101	31.0	-0.1	498	75	71	75	74	67	-0.051	6.90	0.008
66	10.455	10.438	0.16	0.16	1.34	77	1.76	1.06	78	1.60	111	0.047	103	101	31.0	0.0	496	75	71	75	74	67	-0.050	6.59	0.018
67	10.615	10.597	0.16	0.16	1.34	77	1.75	1.06	78	1.60	111	0.046	104	103	30.9	-0.1	490	75	71	75	74	66	-0.049	5.28	0.022
68	10.775	10.755	0.16	0.16	1.34	77	1.75	1.06	78	1.60	111	0.048	102	100	30.9	0.0	484	75	71	75	74	68	-0.048	4.73	0.028
69	10.935	10.914	0.16	0.16	1.34	77	1.76	1.06	78	1.60	111	0.047	103	102	30.8	-0.1	476	75	71	75	74	67	-0.048	5.11	0.022
70	11.094	11.072	0.16	0.16	1.33	77	1.76	1.06	78	1.60	111	0.047	102	101	30.7	-0.1	475	75	71	75	74	66	-0.048	4.32	0.035
71	11.254	11.231	0.16	0.16	1.34	77	1.76	1.06	78	1.60	110	0.047	103	102	30.7	0.0	467	75	71	75	74	66	-0.047	5.42	0.018
72	11.414	11.390	0.16	0.16	1.34	77	1.76	1.06	78	1.60	110	0.048	102	101	30.6	-0.1	463	75	71	75	74	67	-0.047	4.63	0.019
73	11.574	11.548	0.16	0.16	1.34	77	1.76	1.06	78	1.60	110	0.048	102	100	30.5	-0.1	456	75	71	74	74	67	-0.045	4.56	0.020
74	11.733	11.707	0.16	0.16	1.34	77	1.77	1.06	78	1.60	109	0.047	102	102	30.5	0.0	454	75	71	74	74	67	-0.046	4.28	0.034
75	11.893	11.866	0.16	0.16	1.34	78	1.77	1.05	78	1.60	109	0.046	104	103	30.4	-0.1	454	75	71	74	74	67	-0.046	4.80	0.021
76	12.053	12.024	0.16	0.16	1.34	78	1.77	1.06	78	1.60	109	0.046	104	102	30.4	0.0	445	75	71	74	74	67	-0.043	4.87	0.030
77	12.213	12.183	0.16	0.16	1.34	78	1.76	1.06	78	1.60	104	0.048	101	100	30.4	0.0	423	75	71	74	73	67	-0.046	3.44	0.051
78	12.373	12.341	0.16	0.16	1.34	78	1.76	1.06	78	1.60	101	0.048	101	99	30.3	-0.1	410	75	71	74	73	67	-0.044	3.39	0.031
79	12.533	12.500	0.16	0.16	1.34	78	1.76	1.06	78	1.60	100	0.048	101	100	30.3	0.0	403	74	71	74	73	67	-0.044	4.43	0.024
80	12.693	12.659	0.16	0.16	1.34	78	1.75	1.05	78	1.60	98	0.046	103	102	30.2	-0.1	391	74	71	74	73	67	-0.042	4.72	0.017
81	12.853	12.817	0.16	0.16	1.34	78	1.76	1.06	78	1.60	97	0.048	101	99	30.2	0.0	381	74	71	74	73	67	-0.041	3.79	0.024
82	13.013	12.977	0.16	0.16	1.34	78	1.76	1.05	78	1.60	96	0.047	101	101	30.2	0.0	368	74	71	74	73	67	-0.040	3.47	0.043
83	13.173	13.134	0.16	0.16	1.34	78	1.77	1.05	78	1.60	95	0.048	100	98	30.1	-0.1	360	74	71	73	73	66	-0.039	2.67	0.040
84	13.333	13.293	0.16	0.16	1.33	78	1.76	1.06	78	1.60	94	0.047	101	100	30.1	0.0	359	74	71	73	73	66	-0.039	3.13	0.044
85	13.493	13.452	0.16	0.16	1.34	78	1.76	1.05	78	1.60	94	0.046	102	101	30.1	-0.1	355	74	71	73	73	66	-0.038	4.12	0.028
86	13.653	13.610	0.16	0.16	1.34	78	1.76	1.06	78	1.60	93	0.047	101	100	30.0	-0.1	350	73	71	73	73	66	-0.038	3.71	0.028
87	13.813	13.769	0.16	0.16	1.34	78	1.76	1.06	78	1.60	93	0.048	100	99	30.0	0.0	351	73	71	73	73	66	-0.039	3.79	0.029
88	13.972	13.928	0.16	0.16	1.34	78	1.76	1.05	78	1.60	92	0.047	100	100	30.0	0.0	346	73	71	73	72	66	-0.038	4.19	0.026
89	14.132	14.086	0.16	0.16	1.34	78	1.76	1.06	78	1.60	92	0.047	101	100	29.9	-0.1	342	73	71	73	72	67	-0.037	3.74	0.023
90	14.292	14.246	0.16	0.16	1.34	78	1.76	1.05	78	1.60	91	0.047	101	101	29.9	0.0	340	73	71	73	72	67	-0.037	3.44	0.030
91	14.452	14.404	0.16	0.16	1.34	78	1.76	1.06	78	1.60	91	0.050	98	96	29.8	-0.1	339	73	70	72	72	67	-0.037	3.56	0.034
92	14.612	14.562	0.16	0.16	1.34	78	1.77	1.05	78	1.60	91	0.046	102	101	29.8	0.0	337	73	70	72	72	67	-0.037	3.83	0.020
93	14.772	14.721	0.16	0.16	1.34	78	1.77	1.06	78	1.60	90	0.047	101	100	29.8	0.0	338	72	70	72	72	67	-0.037	3.82	0.026
94	14.933	14.879	0.16	0.16	1.33	78	1.76	1.05	78	1.60	90	0.048	101	98	29.7	-0.1	337	72	70	72	72	67	-0.037	3.96	0.026
95	15.093	15.039	0.16	0.16	1.34	78	1.76	1.05	78	1.60	90	0.048	100	100	29.7	0.0	336	72	70	72	72	67	-0.037	3.99	0.026
96	15.253	15.197	0.16	0.16	1.34																				

# Pellet Heater Test Data - ASTM E2779 / ASTM E2515

Run: 2

Manufacturer: Hearth & Home  
 Model: P535-C  
 Tracking No.: 2356  
 Project No.: 0061PS086E  
 Test Date: 28-Feb-19  
 Beginning Clock Time: 10:21

High Burn End Time: 61  
 Medium Burn End Time: 182  
 Total Sampling Time: 362 min  
 Recording Interval: 1 min  
 Background Sample Volume: 0 cubic feet

Meter Box Y Factor: 1.022 (1) 0.995 (2) 0 (Amb)

Barometric Pressure: 30.26 30.20 30.14 30.20 "Hg

PM Control Modules: 335, 336  
 Dilution Tunnel MW(dry): 29.00 lb/lb-mole  
 Dilution Tunnel MW(wet): 28.78 lb/lb-mole  
 Dilution Tunnel H2O: 2.00 percent  
 Dilution Tunnel Static: -0.190 "H<sub>2</sub>O  
 Tunnel Area: 0.1963 ft<sup>2</sup>  
 Pitot Tube Cp: 0.99

Avg. Tunnel Velocity: 12.92 ft/sec.  
 Initial Tunnel Flow: 141.3 scfm  
 Average Tunnel Flow: 144.1 scfm  
 Post-Test Leak Check (1): 0.000 cfm @ 7 in. Hg  
 Post-Test Leak Check (2): 0.000 cfm @ 9 in. Hg  
 Fuel Moisture (%): 5.966 Dry Basis 5.630 Wet Basis

Velocity Traverse Data									
	Pt.1	Pt.2	Pt.3	Pt.4	Pt.5	Pt.6	Pt.7	Pt.8	Center
Initial dP	0.028	0.042	0.046	0.040	0.026	0.038	0.042	0.032	0.047
Temp:	108	108	108	108	108	108	108	108	108
V <sub>strav</sub>	13.05			ft/sec			V <sub>scent</sub>	14.82	
F <sub>p</sub>	0.880								

Elapsed Time (min)	Particulate Sampling Data												Fuel Weight (lb)		Temperature Data (°F)							Stack Gas Data			
	Gas Meter 1 (ft <sup>3</sup> )	Gas Meter 2 (ft <sup>3</sup> )	Sample Rate 1 (cfm)	Sample Rate 2 (cfm)	Orifice dH 1 ("H <sub>2</sub> O)	Meter Temp 1 (°F)	Meter Vacuum 1 ("Hg)	Orifice dH 2 ("H <sub>2</sub> O)	Meter Temp 2 (°F)	Meter Vacuum 2 ("Hg)	Dilution Tunnel (°F)	Tunnel Center dP	Pro. Rate 1	Pro. Rate 2	Scale Reading	Weight Change	Stack	Filter 1	Dryer 1	Filter 2	Dryer 2	Ambient	Draft ("H <sub>2</sub> O)	CO <sub>2</sub> (%)	CO (%)
98	15.573	15.515	0.16	0.16	1.33	78	1.77	1.05	78	1.60	89	0.048	100	99	29.6	0.0	327	72	70	72	71	67	-0.036	3.04	0.030
99	15.733	15.673	0.16	0.16	1.33	78	1.76	1.06	78	1.60	89	0.048	100	98	29.6	0.0	328	72	70	72	71	68	-0.036	3.31	0.041
100	15.892	15.832	0.16	0.16	1.33	78	1.76	1.06	78	1.60	89	0.047	100	100	29.5	-0.1	325	72	70	72	71	67	-0.035	4.36	0.022
101	16.052	15.990	0.16	0.16	1.34	78	1.77	1.05	78	1.60	89	0.046	102	100	29.5	0.0	330	72	70	72	71	67	-0.036	3.67	0.035
102	16.212	16.149	0.16	0.16	1.34	78	1.77	1.06	78	1.60	89	0.046	102	101	29.4	-0.1	329	72	70	72	71	67	-0.036	4.21	0.032
103	16.372	16.308	0.16	0.16	1.34	78	1.77	1.06	78	1.60	89	0.048	100	99	29.4	0.0	331	72	70	72	71	67	-0.036	4.04	0.022
104	16.532	16.466	0.16	0.16	1.34	78	1.77	1.05	79	1.60	90	0.048	100	98	29.4	0.0	334	72	70	72	71	67	-0.036	4.16	0.030
105	16.692	16.625	0.16	0.16	1.34	78	1.77	1.06	79	1.60	90	0.047	101	100	29.3	-0.1	333	72	70	72	71	67	-0.036	4.36	0.020
106	16.852	16.784	0.16	0.16	1.34	78	1.76	1.05	79	1.60	90	0.047	101	100	29.3	0.0	331	72	69	72	71	67	-0.036	4.43	0.022
107	17.012	16.942	0.16	0.16	1.34	78	1.77	1.05	79	1.60	90	0.048	100	98	29.3	0.0	329	72	69	72	71	67	-0.036	3.37	0.041
108	17.172	17.102	0.16	0.16	1.34	78	1.77	1.05	79	1.60	89	0.048	100	99	29.2	-0.1	330	72	69	71	71	67	-0.037	3.57	0.029
109	17.333	17.259	0.16	0.16	1.34	78	1.77	1.05	79	1.60	90	0.046	103	100	29.2	0.0	332	71	69	71	71	67	-0.037	3.90	0.027
110	17.493	17.418	0.16	0.16	1.33	78	1.77	1.06	79	1.60	90	0.047	101	100	29.1	-0.1	335	71	69	71	71	67	-0.037	4.44	0.024
111	17.653	17.577	0.16	0.16	1.34	78	1.77	1.06	79	1.60	90	0.047	101	100	29.1	0.0	335	71	69	71	70	67	-0.036	4.05	0.026
112	17.813	17.735	0.16	0.16	1.34	78	1.77	1.06	79	1.60	90	0.048	100	98	29.1	0.0	334	71	69	71	70	67	-0.035	4.27	0.020
113	17.973	17.894	0.16	0.16	1.33	78	1.77	1.06	79	1.60	90	0.048	100	99	29.0	-0.1	331	71	69	71	70	67	-0.036	4.06	0.028
114	18.132	18.053	0.16	0.16	1.33	78	1.77	1.05	79	1.60	90	0.047	100	100	29.0	0.0	332	71	69	71	70	66	-0.036	3.19	0.052
115	18.292	18.211	0.16	0.16	1.34	78	1.77	1.05	79	1.60	90	0.047	101	99	28.9	-0.1	334	71	69	71	70	67	-0.036	4.10	0.026
116	18.452	18.370	0.16	0.16	1.33	78	1.78	1.05	79	1.60	90	0.048	100	99	28.9	0.0	333	71	69	71	70	67	-0.036	4.07	0.027
117	18.612	18.528	0.16	0.16	1.33	78	1.77	1.05	79	1.60	90	0.048	100	98	28.9	0.0	329	71	69	71	70	66	-0.036	3.90	0.025
118	18.772	18.687	0.16	0.16	1.33	78	1.78	1.06	79	1.60	90	0.047	101	100	28.8	-0.1	331	71	69	71	70	67	-0.036	3.30	0.048
119	18.931	18.846	0.16	0.16	1.34	78	1.78	1.05	79	1.60	90	0.046	101	101	28.8	0.0	333	71	69	71	70	67	-0.036	3.95	0.031
120	19.091	19.004	0.16	0.16	1.34	78	1.77	1.06	79	1.60	90	0.047	101	99	28.9	0.1	328	71	69	71	70	67	-0.036	4.58	0.021
121	19.251	19.164	0.16	0.16	1.34	78	1.78	1.05	79	1.60	90	0.047	101	100	28.7	-0.2	331	71	69	71	70	67	-0.036	3.43	0.041
122	19.411	19.321	0.16	0.16	1.34	78	1.78	1.05	79	1.60	90	0.046	102	100	28.7	0.0	331	71	69	71	70	67	-0.035	4.12	0.026
123	19.571	19.480	0.16	0.16	1.34	78	1.78	1.06	79	1.60	90	0.047	101	100	28.6	-0.1	332	71	69	71	70	67	-0.036	3.78	0.031
124	19.731	19.639	0.16	0.16	1.32	78	1.78	1.05	79	1.60	90	0.046	102	101	28.6	0.0	333	71	69	71	70	67	-0.036	4.03	0.025
125	19.891	19.797	0.16	0.16	1.33	79	1.78	1.05	79	1.60	90	0.047	101	99	28.6	0.0	333	71	69	71	70	67	-0.036	4.08	0.029
126	20.051	19.956	0.16	0.16	1.33	78	1.78	1.06	79	1.60	91	0.047	101	100	28.5	-0.1	335	71	69	71	70	67	-0.036	3.94	0.026
127	20.210	20.114	0.16	0.16	1.33	78	1.78	1.05	79	1.60	91	0.047	100	99	28.5	0.0	336	71	69	71	70	67	-0.036	4.29	0.026
128	20.370	20.273	0.16	0.16	1.33	79	1.79	1.05	79	1.60	91	0.046	102	101	28.5	0.0	334	71	69	71	70	67	-0.036	4.21	0.026
129	20.530	20.432	0.16	0.16	1.33	78	1.78	1.05	79	1.60	91	0.047	101	100	28.4	-0.1	334	71	69	71	70	67	-0.036	3.56	0.038
130	20.689	20.590	0.16	0.16	1.33	78	1.78	1.05	79	1.60	91	0.046	101	100	28.4	0.0	334	71	69	71	70	66	-0.036	3.62	0.026
131	20.849	20.749	0.16	0.16	1.33	78	1.78	1.05	79	1.60	90	0.046	102	101	28.3	-0.1	329	71	69	71	70	67	-0.036	4.05	0.027
132	21.008	20.907	0.16	0.16	1.33	79	1.79	1.05	79	1.60	90	0.046	101	100	28.3	0.0	328	71	69	71	70	67	-0.035	3.65	0.038
133	21.168	21.065	0.16	0.16	1.33	79	1.79	1.05	79	1.60	90	0.048	100	98	28.3	0.0	326	71	69	71	70	68	-0.035	3.59	0.036
134	21.328	21.225	0.16	0.16	1.33	79	1.78	1.05	79	1.60	90	0.047	101	100	28.3	0.0	321	71	69	71	70	67	-0.034	3.32	0.041
135	21.488	21.382	0.16	0.16	1.34	79	1.79	1.05	79	1.60	90	0.047	101	99	28.2	-0.1	320	71	68	71	69	67	-0.034	3.59	0.037
136	21.648	21.541	0.16	0.16	1.33	79	1.79	1.05	79	1.60	90	0.047	101	100	28.2	0.0	319	71	68	71	69	67	-0.035	2.97	0.040
137	21.807	21.700	0.16	0.16	1.33	79	1.79	1.05	79	1.60	90	0.046	101	101	28.1	-0.1	320	71	68	71	69	67	-0.034	3.46	0.025
138	21.967	21.858	0.16	0.16	1.32	79	1.79	1.05	79	1.60	90	0.047	101	99	28.1	0.0	322	71	68	71	69	67	-0.034	3.73	0.031
139	22.126	22.017	0.16	0.16	1.32	79	1.79	1.05	79	1.60	90	0.046	101	101	28.1	0.0	325	71	68	71	69	67	-0.036	3.68	0.030
140	22.286	22.175	0.16	0.16	1.33	79	1.78	1.05	79	1.60	90	0.048	100	98	28.0	-0.1	327	71	68	71	69	67	-0.035	3.98	0.022
141	22.445	22.333	0.16	0.16	1.33	79	1.79	1.05	79	1.60	90	0.047	100	99	28.0	0.0	330	71	68	71	69	67	-0.036	4.43	0.022
142	22.604	22.492	0.16	0.16	1.32	79	1.79	1.05	79	1.60	90	0.047	100	100	27.9	-0.1	332	71	68	71	69	67	-0.036	4.09	0.029
143	22.763	22.650	0.16	0.16	1.33	79	1.79	1.05	79	1.60	90	0.048	99	98	27.9	0.0	332	71	68	71	69	67	-0.036	4.39	0.026
144	22.923	22.809	0.16	0.16	1.33	79	1.79	1.05	79	1.60	91	0.049	99	98	27.9	0.0	334	71	68	7					

### Pellet Heater Test Data - ASTM E2779 / ASTM E2515

Run: 2

Manufacturer: Hearth & Home High Burn End Time: 61  
 Model: PS35-C Medium Burn End Time: 182  
 Tracking No.: 2356 Total Sampling Time: 362 min  
 Project No.: 0061PS086E Recording Interval: 1 min  
 Test Date: 28-Feb-19  
 Beginning Clock Time: 10:21 Background Sample Volume: 0 cubic feet

Meter Box Y Factor: 1.022 (1) 0.995 (2) 0 (Amb)

Barometric Pressure: Begin Middle End Average  
30.26 30.20 30.14 30.20 °Hg

PM Control Modules: 335, 336  
 Dilution Tunnel MW(dry): 29.00 lb/lb-mole  
 Dilution Tunnel MW(wet): 28.78 lb/lb-mole  
 Dilution Tunnel H<sub>2</sub>O: 2.00 percent  
 Dilution Tunnel Static: -0.190 H<sub>2</sub>O  
 Tunnel Area: 0.1963 ft<sup>2</sup>  
 Pitot Tube Cp: 0.99

Avg. Tunnel Velocity: 12.92 ft/sec.  
 Initial Tunnel Flow: 141.3 scfm  
 Average Tunnel Flow: 144.1 scfm  
 Post-Test Leak Check (1): 0.000 cfm @ 7 in. Hg  
 Post-Test Leak Check (2): 0.000 cfm @ 9 in. Hg  
 Fuel Moisture (%): 5.966 Dry Basis 5.630 Wet Basis

Velocity Traverse Data									
	Pt.1	Pt.2	Pt.3	Pt.4	Pt.5	Pt.6	Pt.7	Pt.8	Center
Initial dP	<u>0.028</u>	<u>0.042</u>	<u>0.046</u>	<u>0.040</u>	<u>0.026</u>	<u>0.038</u>	<u>0.042</u>	<u>0.032</u>	<u>0.047</u>
Temp:	<u>108</u>	<u>108</u>	<u>108</u>	<u>108</u>	<u>108</u>	<u>108</u>	<u>108</u>	<u>108</u>	<u>108</u>
	V <sub>strav</sub> 13.05 ft/sec			V <sub>scent</sub> 14.82 ft/sec			F <sub>p</sub> 0.880		

Elapsed Time (min)	Particulate Sampling Data											Fuel Weight (lb)		Temperature Data (°F)						Stack Gas Data					
	Gas Meter 1 (ft <sup>3</sup> )	Gas Meter 2 (ft <sup>3</sup> )	Sample Rate 1 (cfm)	Sample Rate 2 (cfm)	Orifice dH 1 (H <sub>2</sub> O)	Meter Temp 1 (°F)	Meter Vacuum 1 (°Hg)	Orifice dH 2 (H <sub>2</sub> O)	Meter Temp 2 (°F)	Meter Vacuum 2 (°Hg)	Dilution Tunnel (°F)	Tunnel Center dP	Pro. Rate 1	Pro. Rate 2	Scale Reading	Weight Change	Stack	Filter 1	Dryer 1	Filter 2	Dryer 2	Ambient	Draft (H <sub>2</sub> O)	CO <sub>2</sub> (%)	CO (%)
147	23.402	23.284	0.16	0.16	1.32	79	1.79	1.05	79	1.60	91	0.047	101	99	27.7	-0.1	334	71	68	71	69	68	-0.036	4.06	0.026
148	23.562	23.442	0.16	0.16	1.33	79	1.79	1.05	79	1.60	91	0.046	102	100	27.7	0.0	329	71	68	71	69	68	-0.036	3.99	0.027
149	23.721	23.601	0.16	0.16	1.33	79	1.79	1.05	79	1.60	91	0.047	100	100	27.7	0.0	331	71	68	71	69	68	-0.036	3.52	0.029
150	23.880	23.759	0.16	0.16	1.32	79	1.79	1.05	79	1.60	91	0.048	99	98	27.6	-0.1	332	71	68	71	69	68	-0.036	3.83	0.029
151	24.039	23.917	0.16	0.16	1.32	79	1.80	1.05	79	1.60	91	0.048	99	98	27.6	0.0	333	71	68	71	69	67	-0.036	3.97	0.029
152	24.199	24.076	0.16	0.16	1.32	79	1.80	1.05	79	1.60	91	0.047	101	100	27.6	0.0	333	71	68	71	69	67	-0.036	4.08	0.026
153	24.358	24.234	0.16	0.16	1.33	79	1.79	1.05	79	1.60	91	0.048	99	98	27.5	-0.1	337	71	68	71	69	67	-0.037	4.30	0.027
154	24.517	24.393	0.16	0.16	1.33	79	1.79	1.06	79	1.60	91	0.048	99	99	27.5	0.0	331	71	68	71	69	68	-0.036	3.88	0.033
155	24.676	24.551	0.16	0.16	1.33	79	1.80	1.04	79	1.60	91	0.047	100	99	27.4	-0.1	332	71	68	71	69	67	-0.036	4.68	0.027
156	24.836	24.709	0.16	0.16	1.32	79	1.80	1.05	79	1.60	91	0.048	100	98	27.4	0.0	330	71	68	71	69	67	-0.037	3.06	0.072
157	24.995	24.868	0.16	0.16	1.32	79	1.80	1.05	79	1.60	91	0.046	101	101	27.4	0.0	328	71	68	71	69	67	-0.036	3.74	0.036
158	25.155	25.026	0.16	0.16	1.32	79	1.80	1.05	79	1.60	91	0.048	100	98	27.3	-0.1	326	71	68	71	69	67	-0.036	3.98	0.031
159	25.314	25.184	0.16	0.16	1.33	79	1.80	1.05	79	1.60	91	0.047	100	99	27.3	0.0	328	71	68	71	69	67	-0.036	3.31	0.033
160	25.473	25.343	0.16	0.16	1.31	79	1.79	1.05	79	1.60	91	0.048	99	99	27.3	0.0	326	71	68	71	69	67	-0.036	3.61	0.031
161	25.632	25.501	0.16	0.16	1.32	79	1.80	1.05	79	1.60	91	0.048	99	98	27.2	-0.1	326	71	68	71	69	67	-0.035	4.26	0.018
162	25.791	25.660	0.16	0.16	1.32	79	1.80	1.05	79	1.60	90	0.047	100	100	27.2	0.0	324	71	68	71	69	67	-0.035	3.53	0.038
163	25.950	25.818	0.16	0.16	1.32	79	1.80	1.05	79	1.60	90	0.047	100	99	27.2	0.0	323	71	68	71	69	67	-0.036	3.70	0.035
164	26.109	25.976	0.16	0.16	1.32	79	1.80	1.05	79	1.60	90	0.047	100	99	27.1	-0.1	326	71	68	71	69	67	-0.036	3.55	0.037
165	26.268	26.134	0.16	0.16	1.32	79	1.80	1.05	79	1.60	90	0.047	100	99	27.1	0.0	327	71	68	71	69	67	-0.036	3.72	0.033
166	26.428	26.292	0.16	0.16	1.33	79	1.80	1.05	79	1.60	90	0.047	101	99	27.0	-0.1	327	71	68	71	69	67	-0.036	4.06	0.029
167	26.587	26.451	0.16	0.16	1.32	79	1.81	1.05	79	1.60	90	0.046	101	101	27.0	0.0	329	71	68	71	69	67	-0.037	4.00	0.024
168	26.747	26.609	0.16	0.16	1.32	79	1.80	1.05	79	1.60	91	0.049	99	97	26.9	-0.1	329	71	68	71	69	66	-0.037	3.73	0.031
169	26.906	26.767	0.16	0.16	1.32	79	1.80	1.05	79	1.60	91	0.046	101	100	26.9	0.0	332	71	68	71	69	67	-0.037	4.22	0.024
170	27.065	26.925	0.16	0.16	1.32	79	1.81	1.05	79	1.60	91	0.049	98	97	26.9	0.0	334	71	68	71	69	67	-0.038	3.92	0.026
171	27.223	27.084	0.16	0.16	1.31	79	1.80	1.04	79	1.60	91	0.047	100	100	26.8	-0.1	332	71	68	71	69	67	-0.038	4.43	0.021
172	27.382	27.242	0.16	0.16	1.32	79	1.80	1.05	79	1.60	91	0.050	97	96	26.8	0.0	335	71	68	71	69	67	-0.039	4.52	0.029
173	27.541	27.400	0.16	0.16	1.33	79	1.81	1.05	79	1.60	91	0.048	99	98	26.8	0.0	335	71	68	71	69	67	-0.038	3.99	0.035
174	27.702	27.560	0.16	0.16	1.34	79	1.83	1.09	79	1.70	90	0.051	97	96	26.7	-0.1	333	71	68	71	69	66	-0.038	4.21	0.036
175	27.862	27.722	0.16	0.16	1.34	79	1.83	1.09	79	1.70	90	0.050	98	99	26.7	0.0	334	71	68	71	69	65	-0.038	4.21	0.030
176	28.022	27.883	0.16	0.16	1.34	79	1.83	1.09	79	1.70	91	0.048	100	100	26.6	-0.1	337	71	68	71	69	66	-0.039	3.68	0.031
177	28.182	28.044	0.16	0.16	1.34	79	1.83	1.09	79	1.70	91	0.050	98	98	26.6	0.0	336	71	68	71	69	66	-0.038	4.16	0.023
178	28.342	28.206	0.16	0.16	1.34	79	1.83	1.09	79	1.70	91	0.050	98	99	26.6	0.0	334	71	68	71	69	67	-0.038	4.72	0.017
179	28.502	28.367	0.16	0.16	1.33	79	1.83	1.09	79	1.70	91	0.048	100	100	26.5	-0.1	331	71	68	71	69	67	-0.037	4.12	0.033
180	28.663	28.528	0.16	0.16	1.33	79	1.83	1.09	79	1.70	91	0.049	99	99	26.5	0.0	330	71	68	71	69	67	-0.037	3.81	0.042
181	28.822	28.689	0.16	0.16	1.34	79	1.84	1.09	79	1.70	90	0.049	98	99	26.5	0.0	330	71	68	71	69	67	-0.037	3.51	0.040
182	28.982	28.852	0.16	0.16	1.34	79	1.83	1.09	79	1.70	90	0.048	100	101	26.4	-0.1	324	71	68	71	69	67	-0.036	3.70	0.027
183	29.142	29.012	0.16	0.16	1.33	79	1.83	1.09	79	1.70	89	0.047	101	100	26.4	0.0	314	71	68	71	69	67	-0.036	3.75	0.023
184	29.302	29.173	0.16	0.16	1.34	79	1.84	1.09	79	1.70	88	0.047	101	101	26.4	0.0	304	71	68	71	69	67	-0.034	2.93	0.052
185	29.461	29.335	0.16	0.16	1.33	79	1.83	1.09	79	1.70	87	0.047	100	101	26.4	0.0	298	71	68	71	69	67	-0.034	2.98	0.036
186	29.621	29.497	0.16	0.16	1.33	79	1.84	1.09	79	1.70	86	0.048	99	100	26.4	0.0	289	71	68	71	69	67	-0.032	2.65	0.047
187	29.781	29.657	0.16	0.16	1.33	79	1.83	1.09	79	1.70	86	0.048	99	99	26.3	-0.1	285	71	68	71	69	67	-0.032	2.76	0.037
188	29.941	29.818	0.16	0.16	1.33	79	1.83	1.09	79	1.70	85	0.049	98	99	26.3	0.0	281	71	68	71	69	68	-0.031	2.17	0.056
189	30.101	29.980	0.16	0.16	1.33	79	1.84	1.09	79	1.70	85	0.049	98	99	26.3	0.0	279	71	68	71	69	68	-0.031	2.75	0.040
190	30.260	30.141	0.16	0.16	1.33	79	1.84	1.09	79	1.70	85	0.049	98	99	26.2	-0.1	280	71	68	71	69	67	-0.031	2.81	0.033
191	30.420	30.302	0.16	0.16	1.33	79	1.83	1.09	79	1.70	85	0.048	99	100	26.2	0.0	281	71	68	71	69	68	-0.031	3.00	0.030
192	30.580	30.463	0.16	0.16	1.33	79	1.83	1.09	79	1.70	85	0.048	99	100	26.2	0.0	282	71	68	71	69	67	-0.032	3.24	0.027
193	30.740	30.625	0.16	0.16	1.33	79	1.83	1.09	79	1.70	85	0.047	100	101	26.2	0.0	284	71	68	71	69	67	-0.		

# Pellet Heater Test Data - ASTM E2779 / ASTM E2515

Run: 2

Manufacturer: Hearth & Home High Burn End Time: 61  
 Model: PS35-C Medium Burn End Time: 182  
 Tracking No.: 2356 Total Sampling Time: 362 min  
 Project No.: 0061PS086E Recording Interval: 1 min  
 Test Date: 28-Feb-19  
 Beginning Clock Time: 10:21 Background Sample Volume: 0 cubic feet

Meter Box Y Factor: 1.022 (1) 0.995 (2) 0 (Amb)

Barometric Pressure: 30.26 30.20 30.14 30.20 "Hg

PM Control Modules: 335, 336  
 Dilution Tunnel MW(dry): 29.00 lb/lb-mole  
 Dilution Tunnel MW(wet): 28.78 lb/lb-mole  
 Dilution Tunnel H2O: 2.00 percent  
 Dilution Tunnel Static: -0.190 "H<sub>2</sub>O  
 Tunnel Area: 0.1963 ft<sup>2</sup>  
 Pitot Tube Cp: 0.99

Avg. Tunnel Velocity: 12.92 ft/sec.  
 Initial Tunnel Flow: 141.3 scfm  
 Average Tunnel Flow: 144.1 scfm  
 Post-Test Leak Check (1): 0.000 cfm @ 7 in. Hg  
 Post-Test Leak Check (2): 0.000 cfm @ 9 in. Hg  
 Fuel Moisture (%): 5.966 Dry Basis 5.630 Wet Basis

Velocity Traverse Data									
	Pt.1	Pt.2	Pt.3	Pt.4	Pt.5	Pt.6	Pt.7	Pt.8	Center
Initial dP	0.028	0.042	0.046	0.040	0.026	0.038	0.042	0.032	0.047
Temp:	108	108	108	108	108	108	108	108	108
	V <sub>strav</sub> 13.05 ft/sec			V <sub>scent</sub> 14.82 ft/sec			F <sub>p</sub> 0.880		

Elapsed Time (min)	Particulate Sampling Data											Fuel Weight (lb)		Temperature Data (°F)						Stack Gas Data					
	Gas Meter 1 (ft <sup>3</sup> )	Gas Meter 2 (ft <sup>3</sup> )	Sample Rate 1 (cfm)	Sample Rate 2 (cfm)	Orifice dH 1 ("H <sub>2</sub> O)	Meter Temp 1 (°F)	Meter Vacuum 1 ("Hg)	Orifice dH 2 ("H <sub>2</sub> O)	Meter Temp 2 (°F)	Meter Vacuum 2 ("Hg)	Dilution Tunnel (°F)	Tunnel Center dP	Pro. Rate 1	Pro. Rate 2	Scale Reading	Weight Change	Stack	Filter 1	Dryer 1	Filter 2	Dryer 2	Ambient	Draft ("H <sub>2</sub> O)	CO <sub>2</sub> (%)	CO (%)
196	31.219	31.108	0.16	0.16	1.32	79	1.84	1.09	79	1.70	84	0.046	101	102	26.1	0.0	275	71	68	71	69	67	-0.031	3.55	0.031
197	31.378	31.269	0.16	0.16	1.33	79	1.84	1.09	79	1.70	84	0.047	100	101	26.1	0.0	275	71	68	71	69	67	-0.031	2.91	0.043
198	31.538	31.430	0.16	0.16	1.33	79	1.83	1.09	79	1.70	84	0.048	99	99	26.0	-0.1	274	71	68	71	69	67	-0.031	2.85	0.043
199	31.697	31.591	0.16	0.16	1.33	79	1.84	1.08	79	1.70	84	0.047	100	101	26.0	0.0	274	71	68	71	69	67	-0.031	2.86	0.038
200	31.857	31.753	0.16	0.16	1.33	79	1.84	1.09	79	1.70	84	0.049	98	99	26.0	0.0	275	71	68	71	69	67	-0.031	3.14	0.031
201	32.016	31.913	0.16	0.16	1.33	79	1.84	1.08	79	1.70	84	0.047	100	100	26.0	0.0	274	70	68	71	69	67	-0.030	3.11	0.031
202	32.176	32.074	0.16	0.16	1.33	79	1.84	1.09	79	1.70	83	0.048	99	99	25.9	-0.1	270	70	68	71	69	67	-0.030	3.22	0.034
203	32.336	32.235	0.16	0.16	1.33	79	1.84	1.09	79	1.70	83	0.049	98	98	25.9	0.0	270	70	68	71	69	67	-0.030	3.40	0.034
204	32.496	32.396	0.16	0.16	1.32	79	1.85	1.08	79	1.70	83	0.047	100	100	25.9	0.0	269	70	68	70	69	68	-0.030	3.02	0.037
205	32.655	32.557	0.16	0.16	1.32	79	1.85	1.09	79	1.70	83	0.046	101	102	25.9	0.0	269	70	68	71	69	68	-0.030	2.72	0.044
206	32.814	32.718	0.16	0.16	1.33	79	1.84	1.08	79	1.70	83	0.047	99	100	25.8	-0.1	271	70	68	70	69	67	-0.031	2.96	0.036
207	32.974	32.880	0.16	0.16	1.32	79	1.84	1.08	79	1.70	83	0.049	98	99	25.8	0.0	269	70	68	70	69	67	-0.030	2.88	0.037
208	33.133	33.040	0.16	0.16	1.33	79	1.84	1.08	79	1.70	83	0.047	99	100	25.8	0.0	268	70	68	70	69	68	-0.030	3.07	0.026
209	33.292	33.201	0.16	0.16	1.32	79	1.85	1.08	79	1.70	83	0.048	98	99	25.8	0.0	264	70	68	70	69	67	-0.029	3.40	0.021
210	33.452	33.362	0.16	0.16	1.32	79	1.85	1.09	79	1.70	83	0.047	100	100	25.7	-0.1	266	70	68	70	69	67	-0.029	2.96	0.042
211	33.611	33.523	0.16	0.16	1.33	79	1.85	1.08	79	1.70	83	0.047	99	100	25.7	0.0	266	70	68	70	69	67	-0.030	2.76	0.042
212	33.770	33.684	0.16	0.16	1.33	79	1.85	1.08	79	1.70	83	0.047	99	100	25.7	0.0	269	70	68	70	69	67	-0.030	2.63	0.036
213	33.930	33.845	0.16	0.16	1.33	79	1.85	1.09	79	1.70	83	0.048	99	99	25.7	0.0	269	70	68	70	68	67	-0.030	2.69	0.040
214	34.089	34.006	0.16	0.16	1.33	79	1.85	1.08	79	1.70	83	0.048	98	99	25.6	-0.1	271	70	68	70	68	67	-0.030	3.18	0.032
215	34.249	34.167	0.16	0.16	1.32	79	1.84	1.08	79	1.70	83	0.048	99	99	25.6	0.0	271	70	68	70	68	67	-0.030	3.52	0.028
216	34.409	34.327	0.16	0.16	1.33	79	1.85	1.09	79	1.70	83	0.047	100	100	25.6	0.0	265	70	68	70	68	67	-0.029	3.47	0.024
217	34.568	34.489	0.16	0.16	1.32	79	1.84	1.09	79	1.70	83	0.047	99	101	25.6	0.0	266	70	68	70	68	68	-0.030	3.35	0.026
218	34.727	34.650	0.16	0.16	1.32	79	1.85	1.08	79	1.70	83	0.048	98	99	25.5	-0.1	268	70	68	70	68	68	-0.030	3.62	0.028
219	34.886	34.810	0.16	0.16	1.32	79	1.85	1.09	79	1.70	83	0.046	101	101	25.5	0.0	271	70	68	70	68	68	-0.031	3.11	0.046
220	35.045	34.971	0.16	0.16	1.32	79	1.85	1.08	79	1.70	83	0.047	99	100	25.5	0.0	271	70	68	70	68	68	-0.030	2.48	0.079
221	35.204	35.133	0.16	0.16	1.32	79	1.85	1.08	79	1.70	83	0.047	99	101	25.4	-0.1	270	70	68	70	68	68	-0.030	3.04	0.048
222	35.364	35.293	0.16	0.16	1.33	79	1.86	1.08	79	1.70	83	0.049	98	98	25.4	0.0	270	70	68	70	68	67	-0.030	3.53	0.027
223	35.523	35.454	0.16	0.16	1.33	79	1.85	1.09	79	1.70	83	0.047	99	100	25.4	0.0	268	70	68	70	68	67	-0.030	3.84	0.023
224	35.682	35.615	0.16	0.16	1.33	79	1.86	1.08	79	1.70	83	0.048	98	99	25.4	0.0	266	70	68	70	68	67	-0.029	3.53	0.029
225	35.842	35.776	0.16	0.16	1.33	79	1.85	1.08	79	1.70	83	0.049	98	98	25.3	-0.1	267	70	68	70	68	67	-0.030	3.07	0.045
226	36.002	35.936	0.16	0.16	1.32	79	1.85	1.08	79	1.70	83	0.048	99	99	25.3	0.0	266	70	68	70	68	67	-0.029	3.23	0.035
227	36.161	36.097	0.16	0.16	1.32	79	1.85	1.08	79	1.70	83	0.049	97	98	25.3	0.0	265	70	68	70	68	67	-0.029	2.97	0.041
228	36.320	36.259	0.16	0.16	1.32	79	1.85	1.08	79	1.70	83	0.048	98	100	25.3	0.0	267	70	68	70	68	67	-0.030	2.74	0.046
229	36.478	36.419	0.16	0.16	1.32	79	1.86	1.08	79	1.70	83	0.049	97	98	25.2	-0.1	268	70	68	70	68	67	-0.030	2.91	0.042
230	36.638	36.580	0.16	0.16	1.32	79	1.86	1.08	79	1.70	83	0.049	98	98	25.2	0.0	268	70	68	70	68	67	-0.030	3.14	0.034
231	36.796	36.741	0.16	0.16	1.32	79	1.86	1.08	79	1.70	83	0.048	98	99	25.2	0.0	267	70	67	70	68	68	-0.030	2.99	0.037
232	36.956	36.901	0.16	0.16	1.33	79	1.85	1.08	79	1.70	83	0.048	99	99	25.2	0.0	268	70	67	70	68	68	-0.030	3.16	0.034
233	37.115	37.062	0.16	0.16	1.33	79	1.85	1.08	79	1.70	83	0.049	97	98	25.1	-0.1	266	70	67	70	68	68	-0.029	3.24	0.035
234	37.274	37.223	0.16	0.16	1.32	79	1.86	1.08	79	1.70	83	0.046	101	102	25.1	0.0	265	70	68	70	68	68	-0.030	3.42	0.031
235	37.434	37.384	0.16	0.16	1.32	79	1.86	1.09	79	1.70	83	0.047	100	100	25.1	0.0	265	70	68	70	68	67	-0.030	3.25	0.029
236	37.593	37.544	0.16	0.16	1.32	79	1.86	1.08	79	1.70	83	0.047	99	100	25.1	0.0	264	70	68	70	68	68	-0.029	3.16	0.033
237	37.752	37.705	0.16	0.16	1.31	79	1.86	1.08	79	1.70	83	0.047	99	100	25.0	-0.1	264	70	68	70	68	67	-0.030	3.23	0.033
238	37.910	37.866	0.16	0.16	1.31	79	1.86	1.08	79	1.70	83	0.047	99	100	25.0	0.0	266	70	67	70	68	67	-0.030	3.04	0.032
239	38.069	38.026	0.16	0.16	1.32	79	1.86	1.08	79	1.70	83	0.047	99	100	25.0	0.0	264	70	67	70	68	67	-0.029	2.93	0.035
240	38.228	38.187	0.16	0.16	1.32	79	1.86	1.08	79	1.70	83	0.046	101	102	25.0	0.0	266	70	67	70	68	67	-0.030	2.95	0.038
241	38.387	38.348	0.16	0.16	1.32	79	1.86	1.08	79	1.70	83	0.050	96	97	24.9	-0.1	268	70	67	70	68	67	-0.029	2.80	0.042
242	38.546	38.509	0.16	0.16	1.32	79	1.87	1.07	79	1.70	83	0.049	97	98	24.9	0.0	267	70	67	70	68	67	-0.030	2.94	0.040
243	38.705	38.669	0.16	0.16																					

### Pellet Heater Test Data - ASTM E2779 / ASTM E2515

Run: 2

Manufacturer: Hearth & Home High Burn End Time: 61  
 Model: PS35-C Medium Burn End Time: 182  
 Tracking No.: 2356 Total Sampling Time: 362 min  
 Project No.: 0061PS086E Recording Interval: 1 min  
 Test Date: 28-Feb-19  
 Beginning Clock Time: 10:21 Background Sample Volume: 0 cubic feet

Meter Box Y Factor: 1.022 (1) 0.995 (2) 0 (Amb)

Barometric Pressure: Begin Middle End Average  
30.26 30.20 30.14 30.20 <sup>°Hg</sup>

PM Control Modules: 335, 336

Dilution Tunnel MW(dry): 29.00 lb/lb-mole  
 Dilution Tunnel MW(wet): 28.78 lb/lb-mole  
 Dilution Tunnel H2O: 2.00 percent  
 Dilution Tunnel Static: -0.190 <sup>°H<sub>2</sub>O</sup>  
 Tunnel Area: 0.1963 <sup>ft<sup>2</sup></sup>  
 Pitot Tube Cp: 0.99

Avg. Tunnel Velocity: 12.92 ft/sec.  
 Initial Tunnel Flow: 141.3 scfm  
 Average Tunnel Flow: 144.1 scfm  
 Post-Test Leak Check (1): 0.000 cfm @ 7 in. Hg  
 Post-Test Leak Check (2): 0.000 cfm @ 9 in. Hg  
 Fuel Moisture (%): 5.966 Dry Basis 5.630 Wet Basis

Velocity Traverse Data									
	Pt.1	Pt.2	Pt.3	Pt.4	Pt.5	Pt.6	Pt.7	Pt.8	Center
Initial dP	0.028	0.042	0.046	0.040	0.026	0.038	0.042	0.032	0.047
Temp:	108	108	108	108	108	108	108	108	108

V<sub>strav</sub> 13.05 ft/sec V<sub>scent</sub> 14.82 ft/sec F<sub>p</sub> 0.880

Elapsed Time (min)	Particulate Sampling Data											Fuel Weight (lb)		Temperature Data (°F)							Stack Gas Data				
	Gas Meter 1 (ft <sup>3</sup> )	Gas Meter 2 (ft <sup>3</sup> )	Sample Rate 1 (cfm)	Sample Rate 2 (cfm)	Orifice dH 1 (°H <sub>2</sub> O)	Meter Temp 1 (°F)	Meter Vacuum 1 (°Hg)	Orifice dH 2 (°H <sub>2</sub> O)	Meter Temp 2 (°F)	Meter Vacuum 2 (°Hg)	Dilution Tunnel (°F)	Tunnel Center dP	Pro. Rate 1	Pro. Rate 2	Scale Reading	Weight Change	Stack	Filter 1	Dryer 1	Filter 2	Dryer 2	Ambient	Draft (°H <sub>2</sub> O)	CO <sub>2</sub> (%)	CO (%)
245	39.024	38.991	0.16	0.16	1.31	79	1.87	1.08	79	1.70	83	0.048	98	99	24.8	-0.1	267	70	68	70	68	67	-0.030	3.17	0.045
246	39.183	39.151	0.16	0.16	1.32	79	1.87	1.08	79	1.70	83	0.048	98	99	24.8	0.0	267	70	67	70	68	67	-0.030	3.54	0.033
247	39.342	39.312	0.16	0.16	1.32	79	1.87	1.08	79	1.70	83	0.050	96	97	24.8	0.0	267	70	68	70	68	66	-0.030	3.28	0.033
248	39.501	39.474	0.16	0.16	1.32	79	1.87	1.08	79	1.70	84	0.048	99	100	24.7	-0.1	268	70	67	70	68	67	-0.030	3.27	0.032
249	39.659	39.634	0.16	0.16	1.32	79	1.87	1.08	79	1.70	84	0.050	96	97	24.7	0.0	272	70	67	70	68	67	-0.030	3.38	0.032
250	39.818	39.794	0.16	0.16	1.32	79	1.87	1.08	79	1.70	84	0.048	99	99	24.7	0.0	271	70	67	70	68	67	-0.030	3.19	0.043
251	39.977	39.956	0.16	0.16	1.32	79	1.87	1.08	79	1.70	84	0.049	98	99	24.7	0.0	272	70	67	70	68	67	-0.030	3.08	0.049
252	40.137	40.116	0.16	0.16	1.32	79	1.87	1.08	79	1.70	84	0.047	100	100	24.6	-0.1	269	70	67	70	68	68	-0.029	3.10	0.045
253	40.296	40.276	0.16	0.16	1.32	79	1.87	1.08	79	1.70	84	0.048	99	99	24.6	0.0	268	70	67	70	68	68	-0.030	3.10	0.040
254	40.455	40.437	0.16	0.16	1.31	79	1.87	1.08	79	1.70	84	0.049	98	98	24.6	0.0	269	70	67	70	68	67	-0.030	3.19	0.038
255	40.614	40.598	0.16	0.16	1.31	79	1.87	1.08	79	1.70	84	0.048	99	99	24.6	0.0	266	70	67	70	68	67	-0.029	3.44	0.030
256	40.773	40.758	0.16	0.16	1.31	79	1.87	1.08	79	1.70	84	0.047	100	100	24.5	-0.1	266	70	67	70	68	68	-0.029	3.42	0.032
257	40.931	40.919	0.16	0.16	1.31	79	1.87	1.07	79	1.70	84	0.050	96	97	24.5	0.0	267	70	67	70	68	68	-0.029	3.33	0.036
258	41.090	41.080	0.16	0.16	1.31	79	1.87	1.08	79	1.70	84	0.047	100	101	24.5	0.0	270	70	67	70	68	68	-0.030	3.03	0.051
259	41.249	41.240	0.16	0.16	1.32	79	1.87	1.08	79	1.80	84	0.047	100	100	24.5	0.0	271	70	67	70	68	68	-0.030	2.89	0.061
260	41.407	41.400	0.16	0.16	1.31	79	1.87	1.08	79	1.70	84	0.047	99	100	24.4	-0.1	269	70	67	70	68	67	-0.030	2.89	0.051
261	41.567	41.562	0.16	0.16	1.31	79	1.88	1.07	79	1.70	84	0.049	98	99	24.4	0.0	270	70	67	70	68	68	-0.031	2.78	0.047
262	41.726	41.722	0.16	0.16	1.31	79	1.87	1.07	79	1.70	84	0.048	99	99	24.4	0.0	272	70	67	70	68	67	-0.030	2.95	0.038
263	41.884	41.882	0.16	0.16	1.32	79	1.87	1.08	79	1.70	84	0.048	98	99	24.4	0.0	268	70	67	70	68	68	-0.029	3.20	0.030
264	42.043	42.043	0.16	0.16	1.31	79	1.87	1.08	79	1.80	84	0.048	99	99	24.3	-0.1	271	70	67	70	68	68	-0.030	3.44	0.025
265	42.201	42.203	0.16	0.16	1.31	79	1.88	1.07	79	1.70	84	0.048	98	99	24.3	0.0	270	70	67	70	68	67	-0.030	3.33	0.029
266	42.360	42.363	0.16	0.16	1.32	79	1.87	1.08	79	1.80	84	0.049	98	98	24.3	0.0	266	70	67	70	68	68	-0.029	3.05	0.043
267	42.518	42.524	0.16	0.16	1.31	79	1.87	1.08	79	1.70	84	0.048	98	99	24.2	-0.1	269	70	67	70	68	68	-0.030	3.13	0.045
268	42.677	42.685	0.16	0.16	1.31	79	1.88	1.08	79	1.80	84	0.046	101	102	24.2	0.0	270	70	67	70	68	68	-0.030	3.39	0.040
269	42.836	42.845	0.16	0.16	1.32	79	1.88	1.08	79	1.80	84	0.048	99	99	24.2	0.0	269	70	67	70	68	68	-0.030	3.13	0.046
270	42.995	43.005	0.16	0.16	1.30	79	1.88	1.07	79	1.70	84	0.048	99	99	24.2	0.0	268	70	67	70	68	68	-0.030	3.14	0.047
271	43.154	43.166	0.16	0.16	1.30	79	1.87	1.08	79	1.80	84	0.047	100	101	24.1	-0.1	271	70	67	70	68	68	-0.030	3.19	0.038
272	43.312	43.326	0.16	0.16	1.31	79	1.87	1.08	79	1.80	84	0.048	98	99	24.1	0.0	272	70	68	70	68	68	-0.031	2.98	0.041
273	43.470	43.486	0.16	0.16	1.31	79	1.87	1.08	79	1.80	84	0.048	98	99	24.1	0.0	271	70	67	70	68	68	-0.030	3.14	0.039
274	43.629	43.647	0.16	0.16	1.31	79	1.88	1.08	79	1.80	84	0.048	99	99	24.1	0.0	270	70	68	70	68	68	-0.030	3.28	0.032
275	43.787	43.807	0.16	0.16	1.32	79	1.88	1.07	79	1.70	84	0.049	97	98	24.0	-0.1	271	70	67	70	68	68	-0.030	3.22	0.033
276	43.946	43.967	0.16	0.16	1.31	79	1.88	1.08	79	1.80	84	0.046	101	101	24.0	0.0	269	70	68	70	68	68	-0.030	3.23	0.033
277	44.105	44.128	0.16	0.16	1.32	79	1.88	1.08	79	1.80	84	0.050	97	97	24.0	0.0	270	70	68	70	68	68	-0.030	3.41	0.030
278	44.264	44.288	0.16	0.16	1.31	79	1.88	1.07	79	1.80	84	0.048	99	99	24.0	0.0	271	70	68	70	68	68	-0.030	3.53	0.031
279	44.422	44.448	0.16	0.16	1.30	79	1.88	1.08	79	1.80	84	0.048	98	99	23.9	-0.1	272	70	68	70	68	69	-0.030	3.19	0.039
280	44.580	44.609	0.16	0.16	1.31	79	1.88	1.08	79	1.80	85	0.046	100	102	23.9	0.0	274	70	68	70	68	68	-0.031	3.19	0.039
281	44.739	44.769	0.16	0.16	1.31	79	1.88	1.07	79	1.80	85	0.046	101	101	23.9	0.0	273	70	68	70	68	68	-0.031	3.19	0.039
282	44.897	44.929	0.16	0.16	1.31	79	1.89	1.07	79	1.80	85	0.048	98	99	23.8	-0.1	273	70	68	71	68	68	-0.031	3.19	0.039
283	45.055	45.089	0.16	0.16	1.31	79	1.88	1.08	79	1.80	84	0.047	99	100	23.8	0.0	277	71	68	71	68	68	-0.032	4.03	0.021
284	45.214	45.250	0.16	0.16	1.31	79	1.88	1.07	79	1.80	84	0.049	98	98	23.8	0.0	270	71	68	71	68	68	-0.031	1.62	0.067
285	45.373	45.410	0.16	0.16	1.31	79	1.88	1.07	79	1.80	84	0.047	100	100	23.8	0.0	268	71	68	71	68	68	-0.031	2.54	0.031
286	45.531	45.570	0.16	0.16	1.30	79	1.89	1.08	79	1.80	84	0.047	99	100	23.7	-0.1	271	71	68	71	68	68	-0.031	3.70	0.022
287	45.690	45.731	0.16	0.16	1.30	79	1.89	1.07	79	1.80	84	0.047	100	101	23.7	0.0	273	71	68	71	68	68	-0.032	3.46	0.020
288	45.848	45.891	0.16	0.16	1.31	79	1.89	1.07	79	1.80	84	0.047	99	100	23.7	0.0	273	71	68	71	68	68	-0.032	3.58	0.044
289	46.006	46.051	0.16	0.16	1.31	79	1.88	1.07	79	1.80	84	0.047	99	100	23.7	0.0	272	71	68	71	68	68	-0.031	2.91	0.042
290	46.164	46.212	0.16	0.16	1.30	79	1.89	1.08	79	1.80	84	0.047	99	101	23.6	-0.1	273	71	68	71	68	68	-0.032	3.66	0.030
291	46.323	46.371	0.16	0.16	1.31	79	1.88	1.08	79	1.80	84	0.047	100	99	23.6	0.0	273	71	68	71	68	68	-0.031	3.69	0.026
292	46.482	46.532	0.16	0.16	1.30	79	1.89	1.07	79	1.80	84	0.047	100	101	23.6	0.0	270	71	68	71	68	68	-0.031		

### Pellet Heater Test Data - ASTM E2779 / ASTM E2515

Run: 2

Manufacturer: Hearth & Home High Burn End Time: 61  
 Model: PS35-C Medium Burn End Time: 182  
 Tracking No.: 2356 Total Sampling Time: 362 min  
 Project No.: 0061PS086E Recording Interval: 1 min  
 Test Date: 28-Feb-19  
 Beginning Clock Time: 10:21 Background Sample Volume: 0 cubic feet

Meter Box Y Factor: 1.022 (1) 0.995 (2) 0 (Amb)

Barometric Pressure: Begin Middle End Average  
30.26 30.20 30.14 30.20 "Hg

PM Control Modules: 335, 336

Dilution Tunnel MW(dry): 29.00 lb/lb-mole  
 Dilution Tunnel MW(wet): 28.78 lb/lb-mole  
 Dilution Tunnel H2O: 2.00 percent  
 Dilution Tunnel Static: -0.190 "H<sub>2</sub>O  
 Tunnel Area: 0.1963 ft<sup>2</sup>  
 Pitot Tube Cp: 0.99

Avg. Tunnel Velocity: 12.92 ft/sec.  
 Initial Tunnel Flow: 141.3 scfm  
 Average Tunnel Flow: 144.1 scfm  
 Post-Test Leak Check (1): 0.000 cfm @ 7 in. Hg  
 Post-Test Leak Check (2): 0.000 cfm @ 9 in. Hg  
 Fuel Moisture (%): 5.966 Dry Basis 5.630 Wet Basis

Velocity Traverse Data									
	Pt.1	Pt.2	Pt.3	Pt.4	Pt.5	Pt.6	Pt.7	Pt.8	Center
Initial dP	0.028	0.042	0.046	0.040	0.026	0.038	0.042	0.032	0.047
Temp:	108	108	108	108	108	108	108	108	108
V <sub>strav</sub>	13.05			ft/sec			V <sub>scent</sub> 14.82 ft/sec		
F <sub>p</sub>	0.880								

Elapsed Time (min)	Particulate Sampling Data											Fuel Weight (lb)		Temperature Data (°F)						Stack Gas Data					
	Gas Meter 1 (ft <sup>3</sup> )	Gas Meter 2 (ft <sup>3</sup> )	Sample Rate 1 (cfm)	Sample Rate 2 (cfm)	Orifice dH 1 ("H <sub>2</sub> O)	Meter Temp 1 (°F)	Meter Vacuum 1 ("Hg)	Orifice dH 2 ("H <sub>2</sub> O)	Meter Temp 2 (°F)	Meter Vacuum 2 ("Hg)	Dilution Tunnel (°F)	Tunnel Center dP	Pro. Rate 1	Pro. Rate 2	Scale Reading	Weight Change	Stack	Filter 1	Dryer 1	Filter 2	Dryer 2	Ambient	Draft ("H <sub>2</sub> O)	CO <sub>2</sub> (%)	CO (%)
294	46.798	46.852	0.16	0.16	1.30	79	1.89	1.07	79	1.80	84	0.049	97	97	23.5	-0.1	271	71	68	71	68	68	-0.031	3.00	0.043
295	46.956	47.012	0.16	0.16	1.30	79	1.89	1.07	79	1.80	84	0.048	98	99	23.5	0.0	271	71	68	71	68	68	-0.031	3.35	0.020
296	47.114	47.173	0.16	0.16	1.30	79	1.90	1.08	79	1.80	84	0.047	99	101	23.5	0.0	274	71	68	71	68	68	-0.032	4.19	0.024
297	47.272	47.333	0.16	0.16	1.31	79	1.89	1.06	79	1.80	84	0.048	98	99	23.5	0.0	275	71	68	71	68	68	-0.032	3.07	0.034
298	47.431	47.492	0.16	0.16	1.31	79	1.89	1.08	79	1.80	84	0.046	101	100	23.4	-0.1	273	71	68	71	68	68	-0.031	2.52	0.049
299	47.590	47.653	0.16	0.16	1.29	79	1.89	1.07	79	1.80	84	0.048	99	99	23.4	0.0	278	71	68	71	68	69	-0.033	4.80	0.033
300	47.748	47.813	0.16	0.16	1.30	79	1.89	1.07	79	1.80	84	0.046	100	101	23.4	0.0	275	71	68	71	68	68	-0.032	2.42	0.066
301	47.906	47.973	0.16	0.16	1.29	79	1.89	1.07	79	1.80	84	0.047	99	100	23.3	-0.1	277	71	68	71	68	68	-0.032	3.71	0.023
302	48.064	48.133	0.16	0.16	1.30	79	1.89	1.07	79	1.80	84	0.047	99	100	23.3	0.0	279	71	68	71	68	68	-0.032	3.61	0.025
303	48.221	48.294	0.16	0.16	1.30	79	1.89	1.07	79	1.80	84	0.048	97	99	23.3	0.0	278	71	68	71	68	68	-0.033	3.40	0.048
304	48.380	48.453	0.16	0.16	1.30	79	1.89	1.07	79	1.80	85	0.046	101	100	23.3	0.0	281	71	68	71	68	68	-0.033	3.76	0.030
305	48.538	48.613	0.16	0.16	1.31	79	1.89	1.07	79	1.80	85	0.047	99	100	23.2	-0.1	277	71	68	71	68	68	-0.031	2.41	0.059
306	48.697	48.774	0.16	0.16	1.29	79	1.89	1.07	79	1.80	85	0.047	100	101	23.2	0.0	277	71	68	71	68	69	-0.032	3.57	0.050
307	48.855	48.933	0.16	0.16	1.30	79	1.89	1.07	79	1.80	85	0.047	99	99	23.2	0.0	275	71	68	71	68	68	-0.031	2.32	0.046
308	49.013	49.093	0.16	0.16	1.29	80	1.89	1.07	79	1.80	84	0.047	99	100	23.2	0.0	273	71	68	71	69	68	-0.032	3.02	0.032
309	49.170	49.254	0.16	0.16	1.30	80	1.89	1.06	79	1.80	84	0.046	99	102	23.1	-0.1	276	71	68	71	68	68	-0.032	4.08	0.016
310	49.328	49.413	0.16	0.16	1.30	80	1.90	1.07	79	1.80	84	0.047	99	99	23.1	0.0	272	71	68	71	68	69	-0.031	2.30	0.100
311	49.486	49.573	0.16	0.16	1.30	80	1.89	1.07	79	1.80	84	0.048	98	99	23.1	0.0	268	71	68	71	68	69	-0.031	2.20	0.071
312	49.645	49.734	0.16	0.16	1.30	80	1.90	1.07	80	1.80	84	0.047	99	100	23.1	0.0	273	71	68	71	69	68	-0.031	4.65	0.010
313	49.803	49.893	0.16	0.16	1.30	80	1.89	1.07	80	1.80	84	0.047	99	99	23.0	-0.1	271	71	68	71	69	68	-0.031	2.51	0.034
314	49.961	50.053	0.16	0.16	1.29	80	1.89	1.07	80	1.80	84	0.046	100	101	23.0	0.0	272	71	68	71	69	68	-0.032	3.54	0.029
315	50.118	50.214	0.16	0.16	1.29	80	1.90	1.07	80	1.80	84	0.049	96	98	23.0	0.0	272	71	68	71	69	68	-0.031	3.39	0.029
316	50.276	50.373	0.16	0.16	1.29	80	1.90	1.07	80	1.80	84	0.047	99	99	23.0	0.0	269	71	68	71	68	68	-0.032	2.41	0.058
317	50.434	50.533	0.16	0.16	1.30	80	1.90	1.07	80	1.80	84	0.047	99	100	22.9	-0.1	271	71	68	71	69	69	-0.032	3.68	0.022
318	50.592	50.693	0.16	0.16	1.30	80	1.89	1.07	80	1.80	84	0.048	98	99	22.9	0.0	269	71	68	71	69	69	-0.031	2.52	0.064
319	50.751	50.853	0.16	0.16	1.29	80	1.90	1.07	80	1.80	84	0.048	98	99	22.9	0.0	271	71	68	71	69	68	-0.032	3.79	0.018
320	50.908	51.013	0.16	0.16	1.30	80	1.90	1.07	80	1.80	84	0.047	98	100	22.8	-0.1	272	71	68	71	69	68	-0.032	3.46	0.034
321	51.066	51.173	0.16	0.16	1.29	80	1.90	1.07	80	1.80	84	0.048	98	99	22.8	0.0	271	71	68	71	69	68	-0.032	2.73	0.061
322	51.224	51.333	0.16	0.16	1.30	80	1.90	1.07	80	1.80	84	0.048	98	99	22.8	0.0	272	71	68	71	69	69	-0.032	3.42	0.039
323	51.381	51.493	0.16	0.16	1.30	80	1.90	1.07	80	1.80	84	0.047	98	100	22.8	0.0	271	71	68	71	69	69	-0.032	3.16	0.031
324	51.539	51.653	0.16	0.16	1.30	80	1.90	1.07	80	1.80	84	0.046	100	101	22.7	-0.1	270	71	68	71	69	68	-0.032	2.77	0.036
325	51.698	51.812	0.16	0.16	1.30	80	1.90	1.07	80	1.80	84	0.047	99	99	22.7	0.0	268	71	68	71	69	69	-0.031	2.33	0.071
326	51.856	51.972	0.16	0.16	1.30	80	1.90	1.07	80	1.80	83	0.047	99	100	22.7	0.0	267	71	68	71	69	68	-0.031	3.08	0.047
327	52.013	52.133	0.16	0.16	1.29	80	1.91	1.07	80	1.80	83	0.048	97	99	22.7	0.0	266	71	68	71	69	69	-0.031	2.81	0.035
328	52.171	52.292	0.16	0.16	1.29	80	1.90	1.07	80	1.80	83	0.047	99	99	22.6	-0.1	269	71	68	71	69	69	-0.032	4.16	0.018
329	52.328	52.452	0.16	0.16	1.30	80	1.90	1.07	80	1.80	83	0.047	98	100	22.6	0.0	269	71	68	71	69	69	-0.031	2.98	0.038
330	52.486	52.612	0.16	0.16	1.29	80	1.91	1.07	80	1.80	83	0.048	98	99	22.6	0.0	269	71	68	71	69	68	-0.032	3.07	0.032
331	52.645	52.772	0.16	0.16	1.29	80	1.91	1.07	80	1.80	84	0.047	99	100	22.6	0.0	269	71	68	71	69	68	-0.031	2.58	0.056
332	52.803	52.932	0.16	0.16	1.30	80	1.90	1.07	80	1.80	84	0.047	99	100	22.5	-0.1	272	71	68	71	69	69	-0.032	3.70	0.020
333	52.960	53.092	0.16	0.16	1.28	80	1.91	1.07	80	1.80	84	0.048	97	99	22.5	0.0	275	71	68	71	69	69	-0.032	4.21	0.025
334	53.117	53.252	0.16	0.16	1.30	80	1.90	1.07	80	1.80	84	0.048	97	99	22.5	0.0	274	71	68	71	69	68	-0.032	3.13	0.039
335	53.275	53.411	0.16	0.16	1.30	80	1.91	1.07	80	1.80	84	0.048	98	98	22.4	-0.1	274	71	68	71	69	69	-0.032	3.72	0.042
336	53.433	53.572	0.16	0.16	1.30	80	1.91	1.07	80	1.80	84	0.047	99	100	22.4	0.0	275	71	68	71	69	68	-0.032	3.78	0.030
337	53.591	53.731	0.16	0.16	1.29	80	1.91	1.07	80	1.80	84	0.049	97	97	22.4	0.0	273	71	68	71	69	69	-0.032	2.28	0.086
338	53.749	53.891	0.16	0.16	1.29	80	1.91	1.07	80	1.80	84	0.048	98	99	22.4	0.0	272	71	68	71	69	69	-0.031	3.02	0.040
339	53.907	54.051	0.16	0.16	1.29	80	1.91	1.07	80	1.80	84	0.046	100	101	22.4	0.0	273	71	68	71	69	68	-0.032	3.20	0.024
340	54.064	54.211	0.16	0.16	1.29	80	1.90	1.07	80	1.80	84	0.046	99	101	22.3	-0.1	269	71	68	71	69	69	-0.031	1.86	0.076
341	54.221	54.371	0.16	0.16	1.30	80	1.91	1.07	80	1.80	84	0.047	98	100	22.3	0.0									

**Pellet Heater Test Data - ASTM E2779 / ASTM E2515**

Run: 2

Manufacturer: Hearth & Home  
 Model: PS35-C  
 Tracking No.: 2356  
 Project No.: 0061PS086E  
 Test Date: 28-Feb-19

High Burn End Time: 61  
 Medium Burn End Time: 182  
 Total Sampling Time: 362 min  
 Recording Interval: 1 min

Beginning Clock Time: 10:21 Background Sample Volume: 0 cubic feet

Meter Box Y Factor: 1.022 (1) 0.995 (2) 0 (Amb)

Barometric Pressure: 

Begin	Middle	End	Average
<u>30.26</u>	<u>30.20</u>	<u>30.14</u>	<u>30.20</u>

 "Hg

PM Control Modules: 335, 336  
 Dilution Tunnel MW(dry): 29.00 lb/lb-mole  
 Dilution Tunnel MW(wet): 28.78 lb/lb-mole  
 Dilution Tunnel H2O: 2.00 percent  
 Dilution Tunnel Static: -0.190 "H<sub>2</sub>O  
 Tunnel Area: 0.1963 ft<sup>2</sup>  
 Pitot Tube Cp: 0.99

Avg. Tunnel Velocity: 12.92 ft/sec.  
 Initial Tunnel Flow: 141.3 scfm  
 Average Tunnel Flow: 144.1 scfm  
 Post-Test Leak Check (1): 0.000 cfm @ 7 in. Hg  
 Post-Test Leak Check (2): 0.000 cfm @ 9 in. Hg  
 Fuel Moisture (%): 5.966 Dry Basis 5.630 Wet Basis

Velocity Traverse Data									
	Pt.1	Pt.2	Pt.3	Pt.4	Pt.5	Pt.6	Pt.7	Pt.8	Center
Initial dP	<u>0.028</u>	<u>0.042</u>	<u>0.046</u>	<u>0.040</u>	<u>0.026</u>	<u>0.038</u>	<u>0.042</u>	<u>0.032</u>	<u>0.047</u>
Temp:	<u>108</u>	<u>108</u>	<u>108</u>	<u>108</u>	<u>108</u>	<u>108</u>	<u>108</u>	<u>108</u>	<u>108</u>
	V <sub>strav</sub> <u>13.05</u> ft/sec			V <sub>scent</sub> <u>14.82</u> ft/sec			F <sub>p</sub> <u>0.880</u>		

Elapsed Time (min)	Particulate Sampling Data											Fuel Weight (lb)		Temperature Data (°F)						Stack Gas Data					
	Gas Meter 1 (ft <sup>3</sup> )	Gas Meter 2 (ft <sup>3</sup> )	Sample Rate 1 (cfm)	Sample Rate 2 (cfm)	Orifice dH 1 ("H <sub>2</sub> O)	Meter Temp 1 (°F)	Meter Vacuum 1 ("Hg)	Orifice dH 2 ("H <sub>2</sub> O)	Meter Temp 2 (°F)	Meter Vacuum 2 ("Hg)	Dilution Tunnel (°F)	Tunnel Center dP	Pro. Rate 1	Pro. Rate 2	Scale Reading	Weight Change	Stack	Filter 1	Dryer 1	Filter 2	Dryer 2	Ambient	Draft ("H <sub>2</sub> O)	CO <sub>2</sub> (%)	CO (%)
343	54.537	54.690	0.16	0.16	1.30	80	1.92	1.07	80	1.80	84	0.046	100	100	22.2	-0.1	271	71	68	71	69	69	-0.032	3.73	0.036
344	54.695	54.850	0.16	0.16	1.29	80	1.91	1.07	80	1.80	84	0.048	98	99	22.2	0.0	273	71	68	71	69	69	-0.032	3.69	0.026
345	54.853	55.011	0.16	0.16	1.28	80	1.91	1.07	80	1.80	84	0.047	99	100	22.2	0.0	270	71	68	71	69	69	-0.031	2.84	0.054
346	55.010	55.170	0.16	0.16	1.29	80	1.91	1.06	80	1.80	84	0.045	100	101	22.2	0.0	270	71	68	71	69	69	-0.032	3.78	0.019
347	55.167	55.330	0.16	0.16	1.30	80	1.92	1.07	80	1.80	84	0.047	98	100	22.1	-0.1	271	71	68	71	69	69	-0.032	3.48	0.031
348	55.325	55.490	0.16	0.16	1.29	80	1.92	1.07	80	1.80	84	0.049	97	98	22.1	0.0	269	71	68	71	69	69	-0.032	2.84	0.065
349	55.483	55.650	0.16	0.16	1.29	80	1.91	1.07	80	1.80	84	0.049	97	98	22.1	0.0	269	71	68	71	69	69	-0.031	2.96	0.054
350	55.641	55.809	0.16	0.16	1.29	80	1.91	1.07	80	1.80	84	0.048	98	98	22.1	0.0	270	71	68	71	69	69	-0.031	3.41	0.019
351	55.798	55.969	0.16	0.16	1.28	80	1.91	1.07	80	1.80	84	0.046	99	101	22.0	-0.1	270	71	68	71	69	69	-0.031	3.44	0.034
352	55.956	56.129	0.16	0.16	1.29	80	1.91	1.07	80	1.80	84	0.049	97	98	22.0	0.0	273	71	68	71	69	69	-0.032	3.79	0.019
353	56.113	56.288	0.16	0.16	1.30	80	1.92	1.07	80	1.80	84	0.046	99	100	22.0	0.0	271	71	68	71	69	69	-0.032	2.33	0.055
354	56.270	56.449	0.16	0.16	1.29	80	1.92	1.07	80	1.80	84	0.049	96	98	21.9	-0.1	273	71	68	71	69	69	-0.033	4.37	0.026
355	56.429	56.608	0.16	0.16	1.29	80	1.92	1.07	80	1.80	84	0.048	98	98	21.9	0.0	274	71	68	71	69	69	-0.033	3.75	0.017
356	56.586	56.767	0.16	0.16	1.28	80	1.92	1.07	80	1.80	83	0.048	97	98	21.9	0.0	272	71	68	71	69	69	-0.032	2.82	0.047
357	56.743	56.928	0.16	0.16	1.29	80	1.92	1.07	80	1.80	84	0.049	96	98	21.9	0.0	272	71	68	71	69	69	-0.032	3.42	0.037
358	56.901	57.087	0.16	0.16	1.28	80	1.92	1.06	80	1.80	83	0.048	98	98	21.8	-0.1	270	71	68	71	69	69	-0.032	2.51	0.075
359	57.058	57.247	0.16	0.16	1.29	80	1.92	1.07	80	1.80	84	0.048	97	99	21.8	0.0	274	71	68	71	69	69	-0.033	4.18	0.014
360	57.215	57.407	0.16	0.16	1.29	80	1.92	1.06	80	1.80	83	0.049	96	98	21.8	0.0	277	71	68	71	69	69	-0.033	4.07	0.015
361	57.374	57.566	0.16	0.16	1.29	80	1.91	1.07	80	1.80	84	0.047	99	99	21.8	0.0	272	71	68	71	69	69	-0.032	1.93	0.120
362	57.531	57.726	0.16	0.16	1.28	80	1.92	1.07	80	1.80	84	0.048	97	99	21.7	-0.1	274	71	68	71	69	69	-0.033	4.08	0.018
Avg/Tot	57.531	57.726	0.16	0.16	1.32	78	1.83	1.06	78	1.67	91	0.05	100	100			336	71	69	71	70	67	-0.037	4.25	0.03

## Pellet Heater Lab Data - ASTM E2779 / ASTM E2515

Manufacturer: Hearth & Home      Equipment Numbers: 283A, 592, 637  
 Model: PS35-C  
 Tracking No.: 2356  
 Project No.: 0061PS086E  
 Run #: 2      Technician Signature:   
 Date: 2/28/19

### TRAIN 1 (First Hour emissions)

Sample Component	Reagent	Filter, Probe or Seal #	Mass Readings		
			Tare, mg	Final, mg	Particulate, mg
A. Front filter catch	Filter	D686	121.3	123.6	2.3
B. Rear filter catch	Filter				0.0
C. Probe catch*	Probe				0.0
D. Filter seals catch*	Seals				0.0
1 <sup>st</sup> hour Sub-Total, mg:					2.3

### TRAIN 1 (Remainder of Test)

Sample Component	Reagent	Filter, Probe or Seal #	Mass Readings		
			Tare, mg	Final, mg	Particulate, mg
A. Front filter catch	Filter	D687	121.0	125.2	4.2
B. Rear filter catch	Filter	D688	120.2	119.9	-0.3
C. Probe catch*	Probe	12	114283.5	114283.5	0.0
D. Filter seals catch*	Seals	R749	4088.6	4089.2	0.6
Remainder Sub-Total, mg:					4.5
Train 1 Aggregate, mg:					6.8

### TRAIN 2

Sample Component	Reagent	Filter, Probe or Seal #	Mass Readings		
			Tare, mg	Final, mg	Particulate, mg
A. Front filter catch	Filter	D689	120.6	127.2	6.6
B. Rear filter catch	Filter	D690	120.6	120.4	-0.2
C. Probe catch*	Probe	16	114266.1	114266.1	0.0
D. Filter seals catch*	Seals	R750	3319.0	3319.4	0.4
Train 2 Aggregate, mg:					6.8

### AMBIENT

Sample Component	Reagent	Filter, Probe or Seal #	Mass Readings		
			Tare, mg	Final, mg	Particulate, mg
A. Front filter catch*	Filter				0.0
Ambient Aggregate, mg:					0.0

\*Particulate catch that results in a negative number, is assumed to be zero for probes and seals, negative numbers for filters are assumed to be included in O-ring seal weights.



Pellet Heater Certification Run Sheets

Client: HHT Project Number: 0061PS086E Run Number: 12  
 Model: PS35-C Tracking Number: 2356 Date: 2/28/2019  
 Test Crew: A. Kravitz  
 OMNI Equipment ID numbers: \_\_\_\_\_

ASTM E2515 Sampling Information

Test Location: E1 Clock Time @ ET=0: 10:21  
 Span Gas Concentrations: CO<sub>2</sub>(%): 17.06 CO(%): 4.280 CO(ppm): 901

Test Run Validation Checks	Pre Test	Post Test
Zero Stack Gas Leakage	✓	✓
Zero Pitot Line Leakage	✓	✓
Zero Induced Draft	✓	
100% Smoke Capture	✓	

Test Run Validation Measurements	Pre Test		Post Test	
Scale Audit (lbs)	10.0		10.0	
CO <sub>2</sub> % (Zero/Span)	0.00	17.06	<del>0.00</del> 0.06	17.10
CO % (Zero/Span)	0.000	4.289	-0.010	4.262
CO ppm (Zero/Span)	0	921	0	899
Sample A Leakage (cfm @ "Hg)	∅		∅ @	-10
Sample B Leakage (cfm @ "Hg)	∅		∅ @	-13
Room Air Velocity (ft/min)	< 50		250	
Barometric Pressure ("Hg)	30.26		30.14	
Relative Humidity (%)	16.1		18.2	
Tunnel Static ("H <sub>2</sub> O)	-0.19		-0.19	

Last Cleaning Dates

Flue Pipe	<u>New</u>
Dilution Tunnel	<u>2/26/19</u>
Sample Dryers	<u>2/26/19</u>

Dilution Tunnel Traverse

Traverse Point	1	2	Center	3	4	5	6	7	8
Δp ("H <sub>2</sub> O)	0.028	0.042	0.047	0.046	0.040	0.026	0.038	0.042	0.032
T (°F)	104	→							

Technician Signature:  Date: 2/28/19

Pellet Heater Certification Run Sheets

Client: HHT Project Number: 0061PS086E Run Number: 12  
 Model: PS35-C Tracking Number: 2356 Date: 2/28/2019  
 Test Crew: A. Kravitz  
 OMNI Equipment ID numbers: \_\_\_\_\_

ASTM E2779 Run Notes

Air Control Settings

High Burn Rate Target: 100%

Settings: Rocker High  
FRAP out  
Board trim 3

Medium Burn Rate Target: <50%

Settings: Rocker Med  
FRAP In  
Board trim 2

Low Burn Rate Target: Minimum

Settings: Rocker Low Board trim 2  
FRAP open 3/8"

Additional Settings Notes:

---

Pellet Moisture Content: 5.634. WB

Pellet Specifications: Sourwood Hardware

Pellet Analysis Notes: \_\_\_\_\_

Preburn Notes

Time	Notes
0:30-0:76 6:00	Cleaned firebox of ash Lost data file, restarted logger

Test Notes

Time	Notes
60:00	Changed filter A
60:10-61:00	Change to Med settings
181-182	Changed to Low
362	Test End

Technician Signature: 

Date: 2/28/19

## **2.2 - Sample Analysis & Tares**

Analysis Worksheets  
Tared Filter, Probe, and O-Ring Data  
Pellet Fuel Label  
Pellet Fuel Analysis Report

## Pellet Heater Lab Data - ASTM E2779 / ASTM E2515

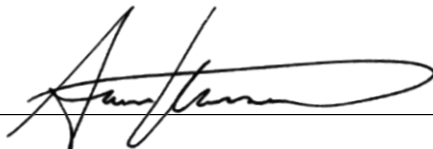
Manufacturer: Hearth & Home      Equipment Numbers: 283A, 592, 637  
 Model: PS35-C  
 Tracking No.: 2356  
 Project No.: 0061PS086E  
 Run #: 2      Technician Signature:   
 Date: 2/28/19

### TRAIN 1 (First Hour emissions)

Sample Component	Reagent	Filter, Probe or Seal #	Mass Readings		
			Tare, mg	Final, mg	Particulate, mg
A. Front filter catch	Filter	D686	121.3	123.6	2.3
B. Rear filter catch	Filter				0.0
C. Probe catch*	Probe				0.0
D. Filter seals catch*	Seals				0.0
1 <sup>st</sup> hour Sub-Total, mg:					2.3

### TRAIN 1 (Remainder of Test)

Sample Component	Reagent	Filter, Probe or Seal #	Mass Readings		
			Tare, mg	Final, mg	Particulate, mg
A. Front filter catch	Filter	D687	121.0	125.2	4.2
B. Rear filter catch	Filter	D688	120.2	119.9	-0.3
C. Probe catch*	Probe	12	114283.5	114283.5	0.0
D. Filter seals catch*	Seals	R749	4088.6	4089.2	0.6
Remainder Sub-Total, mg:					4.5
Train 1 Aggregate, mg:					6.8

### TRAIN 2

Sample Component	Reagent	Filter, Probe or Seal #	Mass Readings		
			Tare, mg	Final, mg	Particulate, mg
A. Front filter catch	Filter	D689	120.6	127.2	6.6
B. Rear filter catch	Filter	D690	120.6	120.4	-0.2
C. Probe catch*	Probe	16	114266.1	114266.1	0.0
D. Filter seals catch*	Seals	R750	3319.0	3319.4	0.4
Train 2 Aggregate, mg:					6.8

### AMBIENT

Sample Component	Reagent	Filter, Probe or Seal #	Mass Readings		
			Tare, mg	Final, mg	Particulate, mg
A. Front filter catch*	Filter				0.0
Ambient Aggregate, mg:					0.0

\*Particulate catch that results in a negative number, is assumed to be zero for probes and seals, negative numbers for filters are assumed to be included in O-ring seal weights.

### Pellet Heater Certification Run Sheets

Client: HHT Project Number: 0061PS086E Run Number: 12  
 Model: PS35-C Tracking Number: 2356 Date: 2/28/2019  
 Test Crew: A. Kravitz  
 OMNI Equipment ID numbers: 637, 522, 283A

#### ASTM E2515 Lab Sheet

Assembled By:

A. Kravitz

Date/Time in Desiccator:

2/28/19 15:30

Weighing #1	Weighing #2	Weighing #3	Weighing #4
Date: <u>3/2/19</u>	Date: <u>3/8/19</u>	Date:	Date:
Time: <u>1030</u>	Time: <u>0830</u>	Time:	Time:
R/H %: <u>14.6</u>	R/H %: <u>12.4</u>	R/H %:	R/H %:
Temp (F): <u>65.7</u>	Temp (F): <u>70.3</u>	Temp (F):	Temp (F):
Audit 1: <u>200.0</u>	Audit 1: <u>200.2</u>	Audit 1:	Audit 1:
Audit 2: <u>2000.4</u>	Audit 2: <u>2000.2</u>	Audit 2:	Audit 2:
Audit 3: <u>9999.7</u>	Audit 3: <u>9999.7</u>	Audit 3:	Audit 3:
Initials: <u>A</u>	Initials: <u>AK</u>	Initials:	Initials:

Train	Item	ID #	Tare (mg)	Weight (mg)	Weight (mg)	Weight (mg)	Weight (mg)
A	Front Filter (60 min)	<u>D686</u>	<u>121.3</u>	<u>123.6</u>	<u>123.6</u>		
A	Front Filter (Remainder)	<u>D687</u>	<u>121.0</u>	<u>125.2</u>	<u>125.2</u>		
A	Rear Filter	<u>D688</u>	<u>120.2</u>	<u>119.8</u>	<u>119.9</u>		
A	Probe	<u>12</u>	<u>114283.5</u>	<u>114283.4</u>	<u>114283.5</u>		
A	O-Ring Set	<u>R749</u>	<u>4088.6</u>	<u>4089.1</u>	<u>4089.2</u>		
B	Front Filter	<u>D689</u>	<u>120.6</u>	<u>127.2</u>	<u>127.2</u>		
B	Rear Filter	<u>D690</u>	<u>120.6</u>	<u>120.4</u>	<u>120.4</u>		
B	Probe	<u>15</u>	<u>114266.1</u>	<u>114266.2</u>	<u>114266.1</u>		
B	O-Ring Set	<u>R750</u>	<u>3319.0</u>	<u>3319.3</u>	<u>3319.4</u>		
BG	Filter	-	-	-	-		

Technician Signature: 

Date: 3/8/19

Tare Sheet: (check one)

Probes \_\_\_\_\_

47mm Filters \_\_\_\_\_

100mm Filters \_\_\_\_\_

O-Ring Pair

Prepared By: B Davis

Balance ID #: OMNI-00637

Thermohyrometer ID #: OMNI-00592

Audit Weight ID #/Mass: OMNI-002824 / 5g

Placed in Dessicator:	Date: <u>1/30/19</u>	Date: <u>1/30/19</u>	Date: <u>2/1/19</u>	Date: _____	Date Used	Project Number	Run No.
	Time: <u>0930</u>	Time: <u>0850</u>	Time: <u>0846</u>	Time: _____			
Date: <u>1/23/19</u>	RH %: <u>18.4</u>	RH %: <u>12.2</u>	RH %: <u>12.2</u>	RH %: _____			
Time: <u>0910</u>	T (°F): <u>71.4</u>	T (°F): <u>71.3</u>	T (°F): <u>71.1</u>	T (°F): _____			
ID #	Audit: <u>5000.0</u>	Audit: <u>5000</u>	Audit: <u>5000.0</u>	Audit: _____			
<u>R 739</u>	<u>3546.7</u>	<u>3546.5</u>	—		<u>2/27/19</u>	<u>0061 PS08LE</u>	<u>1</u>
<u>R 748</u>	<u>3549.3</u>	<u>3549.2</u>	—		<u>2/27/19</u>	<u>0061 PS08LE</u>	<u>1</u>
Initials: <u>BD</u>	Initials: <u>BD</u>	Initials: <u>BD</u>	Initials: _____				

Final Technician Signature: B Davis

Date: 2/1/19

Evaluator signature: [Signature]

Control No. P-SFDP-0002.xls, Effective date: 2/1/2017

Tare Sheet: (check one)

Probes

47mm Filters \_\_\_\_\_

100mm Filters \_\_\_\_\_

O-Ring Pair \_\_\_\_\_

Prepared By: B. Davis

Balance ID #: omni-00637

Thermohyrometer ID #: omni-00592

Audit Weight ID #/Mass: omni-00253A / 100g

Placed in Dessicator:	Date: <u>1/23/19</u>	Date: <u>1/24/19</u>	Date: <u>1/24/19</u>	Date: <u>1/25/19</u>	Date Used	Project Number	Run No.
Date: <u>1/22/19</u>	Time: <u>0840</u>	Time: <u>0910</u>	Time: <u>1600</u>	Time: <u>0802</u>			
Time: <u>0900</u>	RH %: <u>18.6</u>	RH %: <u>19.7</u>	RH %: <u>-</u>	RH %: <u>17.4</u>			
ID #	T (°F): <u>71.7</u>	T (°F): <u>72.1</u>	T (°F): <u>-</u>	T (°F): <u>72.2</u>			
	Audit: <u>99997.9</u>	Audit: <u>99997.8</u>	Audit: <u>-</u>	Audit: <u>99997.8</u>			
9	115692.1	115691.9	-		2/27/19	0061 PS086E	1
11	114186.4	114185.7	114185.7	-	↓	↓	↓
12	114283.7	114283.5	-		2/28/19	↓	2
16	114266.5	114266.1	114266.1	-	↓	↓	↓

Initials: BD Initials: BD Initials: AC Initials: BD

Final Technician Signature: [Signature]  
 Control No. P-SFDP-0002.xls, Effective date: 2/1/2017

Date: 2/20/19

Evaluator signature: [Signature]

Tare Sheet: Probes \_\_\_ 47mm Filters  100mm Filters \_\_\_ O-Ring Pair \_\_\_

Date/time Placed in Dessicator: 1/29/19 0910

Thermohygrometer ID #: Omni-00592

Prepared By: B Davis

Analytical Balance ID #: Omni-00637

Audit Weight ID #/Mass: Omni-00283A / 200 mg

ID #	Date: <u>1/30/19</u> Time: <u>0930</u> RH %: <u>12.0</u> T (°F): <u>71.1</u> Audit: <u>200.1</u>	Date: <u>1/31/19</u> Time: <u>0820</u> RH %: <u>13.7</u> T (°F): <u>70.3</u> Audit: <u>200.1</u>	Date: <u>2/1/19</u> Time: <u>0823</u> RH %: <u>11.0</u> T (°F): <u>71.6</u> Audit: <u>200.1</u>	Date: Time: RH %: T (°F): Audit:	Date Used	Project Number	Run No.
D681	121.5	121.4	-		2/27/19	0061PS086E	1
D682	121.3	121.2	-				
D683	121.1	121.0	-				
D684	120.3	120.1	-				
D685	122.4	122.0	122.2	-	2/28/19		2
D686	121.4	121.1	121.3	-			
D687	120.9	121.0	-				
D688	120.5	120.1	120.2	-			
D689	120.7	120.6	-				
D690	120.6	120.6	-				
D691	120.9	120.6	120.8	-			
D692	120.9	120.6	120.8	-			
D693	120.6	120.6	-				
D694	121.3	121.0	121.2	-			
Initials: <u>BR</u>		Initials: <u>BR</u>		Initials: <u>BR</u>		Initials:	

Final Technician Signature: [Signature]

Date: 2/1/19

Control No. P-SFDP-0001.xls, Effective date: 9/9/2015

Evaluator signature: [Signature]



# Ad hoc O-Ring Tares

Fn dissicator Jan 2019 - OMNI 592, 637

2/27/19  
11.4%  
67.8 °F

2/28/19 - 0800  
9.9%  
71.2 °F

R749

4088.5

4088.6 ✓

R750

3319.0

3319.0 ✓



2/28/19



Twin Ports Testing, Inc.  
 1301 North 3rd Street  
 Superior, WI 54880  
 p: 715-392-7114  
 p: 800-373-2562  
 f: 715-392-7163  
 www.twinportstesting.com

**Report No:** USR:W218-1106-01  
**Issue No:** 1

# Analytical Test Report

**Client:** OMNI-TEST LABORATORIES INC.  
 13327 NE Airport Way  
 Portland, OR 97230  
**Attention:** Finance Department  
**PO No:** 180202

Signed: *Katy Jahr*  
 Katy Jahr  
 Chemistry Lab Supervisor  
 Date of Issue: 11/30/2018  
THIS DOCUMENT SHALL NOT BE REPRODUCED EXCEPT IN FULL

Sample Details			
<b>Sample Log No:</b>	W218-1106-01	<b>Sample Date:</b>	11/20/2018
<b>Sample Designation:</b>	Somerset Hardwood Pellets	<b>Sample Time:</b>	
<b>Sample Recognized As:</b>	Wood Pellets	<b>Arrival Date:</b>	11/26/2018

## Test Results

	METHOD	UNITS	MOISTURE FREE	AS RECEIVED
<b>Moisture Total</b>	ASTM E871	wt. %		5.63
<b>Ash</b>	ASTM D1102	wt. %	0.35	0.33
<b>Volatile Matter</b>	ASTM D3175	wt. %		
<b>Fixed Carbon by Difference</b>	ASTM D3172	wt. %		
<b>Sulfur</b>	ASTM D4239	wt. %	0.041	0.039
<b>SO<sub>2</sub></b>	Calculated	lb/mmbtu		0.097
<b>Net Cal. Value at Const. Pressure</b>	ISO 1928	GJ/tonne	18.51	17.33
<b>Net Cal. Value at Const. Pressure</b>	ISO 1928	J/g	18509	17330
<b>Gross Cal. Value at Const. Vol.</b>	ASTM E711	J/g	19803	18689
<b>Gross Cal. Value at Const. Vol.</b>	ASTM E711	Btu/lb	8514	8035
<b>Carbon</b>	ASTM D5373	wt. %	49.53	46.74
<b>Hydrogen*</b>	ASTM D5373	wt. %	5.94	5.60
<b>Nitrogen</b>	ASTM D5373	wt. %	< 0.20	< 0.19
<b>Oxygen*</b>	ASTM D3176	wt. %	> 43.94	> 41.47

\*Note: As received values do not include hydrogen and oxygen in the total moisture.

<b>Chlorine</b>	ASTM D6721	mg/kg		
<b>Fluorine</b>	ASTM D3761	mg/kg		
<b>Mercury</b>	ASTM D6722	mg/kg		

<b>Bulk Density</b>	ASTM E873	lbs/ft <sup>3</sup>		
<b>Fines (Less than 1/8")</b>	TPT CH-P-06	wt. %		
<b>Durability Index</b>	Kansas State	PDI		
<b>Sample Above 1.50"</b>	TPT CH-P-06	wt. %		
<b>Maximum Length (Single Pellet)</b>	TPT CH-P-06	inch		
<b>Diameter, Range</b>	TPT CH-P-05	inch		to
<b>Diameter, Average</b>	TPT CH-P-05	inch		
<b>Stated Bag Weight</b>	TPT CH-P-01	lbs		
<b>Actual Bag Weight</b>	TPT CH-P-01	lbs		

**Comments**

# **Section 3**

## **Laboratory Quality Assurance**

- 3.1 - Quality Assurance/Quality Control
- 3.2 - Calibration Data
- 3.3 - Example Calculations

### **3.1 - Quality Assurance/Quality Control**

*OMNI* follows the guidelines of ISO/IEC 17025, “General Requirements for the Competence of Testing and Calibration Laboratories,” and the quality assurance/quality control (QA/QC) procedures found in *OMNI*'s Quality Assurance Manual.

*OMNI*'s scope of accreditation includes, but is not limited to, the following:

- ANSI (American National Standards Institute) for certification of product to safety standards.
- To perform product safety testing by the International Accreditation Service, Inc. (formerly ICBO ES) under accreditation as a testing laboratory designated TL-130.
- To perform product safety testing as a “Certification Organization” by the Standards Council of Canada (SCC).
- Serving as a testing laboratory for the certification of wood heaters by the U.S. Environmental Protection Agency.

This report is issued within the scope of *OMNI*'s accreditation. Accreditation certificates are available upon request.

The manufacturing facilities and quality control system for the production of the PS35-C at Hearth & Home Technologies were evaluated to determine if sufficient to maintain conformance with *OMNI*'s requirements for product certification. *OMNI* has concluded that the manufacturing facilities, processes, and quality control system are adequate to produce the appliance congruous with the standards and model codes to which it was evaluated.

This report shall not be reproduced, except in full, without the written approval of *OMNI-Test Laboratories, Inc.*

### 3.2 - Calibration Data

#### Equipment for ASTM E2515, ASTM E2779, & EPA Method 28R

ID #	Lab Name/Purpose	Log Name	Attachment Type
132	10 lb Weight	Weight Standard, 10 lb.	Calibration Certificate
283A	Audit Weights	Troemner 21pc Msas Set	Calibration Certificate
335	Sample Box / Dry Gas Meter	Apex Automated Emissions Sampling Box	Calibration Log
336	Sample Box / Dry Gas Meter	Apex Automated Emissions Sampling Box	Calibration Log
410	Microtector	Dwyer liquid filled pressure indicator	Calibration Certificate
594	Combustion Gas Analyzer	CAI Gas Analyzer	See Run Sheet
559	Vaneometer	Dwyer Vaneometer	Equipment Record
592	Thermohygrometer	Omega Digital Thermohygrometer	Calibration Log
637	Milligram Balance	Analytical Balance - Mettler - Toledo	Calibration Certificate
650	Barometer/Hygrometer	Digital Barometer	Calibration Certificate

## SCALE WEIGHT CALIBRATION DATA SHEET

Weight to be calibrated: 10 pounds

ID Number: OMNI-00132

Standard Calibration Weight: 10 pounds

ID Number: OMNI-00255

Scale Used: MTW-150K

ID Number: OMNI-00353

Date: 2/23/2018 By: B. Davis

Standard Weight (A) (Lb.)	Weight Verified (B) (Lb.)	Difference (A - B)	% Error
10.0	10.0	0.0	0

\*Acceptable tolerance is 1%.

*This calibration is traceable to NIST using calibrated standard weights.*

Technician signature:  Date: 2/23/18

# Certificate of Calibration

Certificate Number: **685888**



**JJ Calibrations, Inc.**

7007 SE Lake Rd  
Portland, OR 97267-2105  
Phone 503.786.3005  
FAX 503.786.2994

**Omni-Test Laboratories**  
13327 NE Airport Way  
Portland, OR 97230

PO: **180188**  
Order Date: **10/09/2018**  
Authorized By: **N/A**



Calibrated on: **10/26/2018**  
\*Recommended Due: **10/26/2023**  
Environment: **20 °C 57 % RH**  
\* As Received: **Within Tolerance**  
\* As Returned: **Within Tolerance**  
Action Taken: **Calibrated**  
Technician: **139**

Property #: **OMNI-00283A**  
User: **N/A**  
Department: **N/A**  
Make: **Troemner Inc**  
Model: **1mg-100g (Class F)**  
Serial #: **47883**  
Description: **Mass Set, 21pc**  
Procedure: **DCN 500901**  
Accuracy: **Class F**

Remarks: \* Many factors may cause the unit to drift out of calibration before the recommended due date. Any reported error is the absolute value between the reference and the unit. Uncertainties include the effects of the unit.

**This set meets Class F specifications.**  
**Received and returned eight (8) masses in a black case secured by a rubber band.**

### Standards Used

Std ID	Manufacturer	Model	Nomenclature	Due Date	Trace ID
723A	Rice Lake	1mg-200g (Class 0)	Mass Set,	03/23/2019	668240
800A	Sartorius	MSA225W100DI	Analytical Balance	12/11/2018	663857

### Measurement Data

Parameter	Measurement Description	Range Unit	Reference	Min	Max	*Error	UUT	Uncertainty
<b>Before/After</b>								Accredited = ✓
<b>Mass</b>								
Dot	200 mg		200.00030	199.4603	200.5403	0.0500	200.0503 mg	6.2E-01 ✓
	1 g		1.00000880	0.9991088	1.0009088	0.0000000	1.0000088 g	1E-03 ✓
	2 g		2.00001470	1.9989147	2.0011147	0.0003250	2.0003397 g	1.3E-03 ✓
	5 g		5.00000840	4.9985084	5.0015084	0.0000400	4.9999684 g	1.7E-03 ✓
	10 g		10.0000100	9.998010	10.002010	0.000245	9.999765 g	2.3E-03 ✓
Dot	20 g		20.0000140	19.996014	20.004014	0.000990	20.001004 g	4.6E-03 ✓
	50 g		49.9999660	49.989966	50.009966	0.000595	49.999371 g	1.1E-02 ✓
	100 g		100.000000	99.98000	100.02000	0.00194	99.99806 g	2.3E-02 ✓

JJ Calibrations, Inc. certifies that this instrument has been calibrated in accordance with the JJ Calibrations Quality Assurance Manual with the stated procedure using standards that are traceable to the National Institute of Standards and Technology (NIST), or other National Measurement Institutes (NMI's), or by using natural physical constants, intrinsic standards or ratio calibration techniques. The quality system and this certificate are in compliance with ANSI/NCCL Z540-1-1994, ISO/IEC 17025-2005, ISO 10012-1, the ISO 9000 family and QS 9000. The expanded uncertainties of measurements for this calibration are based upon 95% (2 sigma) confidence limits. Unless otherwise stated, a test accuracy ratio (TAR) of 4:1, if achievable, is maintained. The results reported herein apply only to the calibration of the item described above. This report may not be reproduced, except in full, without prior written consent of JJ Calibrations, Inc.  
JJ Calibrations, Inc. quality system has been assessed and accredited to ISO/IEC 17025:2005.

  
Reviewer

3 Issued 10/29/2018 Rev # 15

  
Inspector

# Thermal Metering System Calibration Y Factor

Manufacturer: APEX  
 Model: XC-60-EP  
 Serial Number: 606001  
 OMNI Tracking No.: OMNI-00335  
 Calibrated Orifice:  Yes

<b>Average Gas Meter y Factor</b>
<b>1.022</b>

<b>Orifice Meter dH@</b>
<b>N/A</b>

Calibration Date: 01/21/19  
 Calibrated by: B. Davis  
 Calibration Frequency: Six months  
 Next Calibration Due: 7/21/2019  
 Instrument Range: 1.000 cfm  
 Standard Temp.: 68 oF  
 Standard Press.: 29.92 "Hg  
 Barometric Press., Pb: 30.38 "Hg  
 Signature/Date:  1/21/2019

### Previous Calibration Comparison

Date	<u>1/17/2018</u>	Acceptable Deviation (5%)	Deviation
y Factor	<u>0.986</u>	0.0493	0.036
Acceptance	<b>Acceptable</b>		

### Current Calibration

Acceptable y Deviation	0.020
Maximum y Deviation	0.007
Acceptable dH@ Deviation	N/A
Maximum dH@ Deviation	N/A
Acceptance	<b>Acceptable</b>

### Reference Standard \*

Standard	Model	Standard Test Meter
Calibrator	S/N	<u>OMNI-00001</u>
	Calib. Date	<u>14-Nov-18</u>
	Calib. Value	<u>0.9981</u> y factor (ref)

Calibration Parameters	Run 1	Run 2	Run 3
Reference Meter Pressure ("H2O), Pr	<u>0.00</u>	<u>0.00</u>	<u>0.00</u>
DGM Pressure ("H2O), Pd	<u>2.00</u>	<u>1.38</u>	<u>1.00</u>
Initial Reference Meter	<u>983.3</u>	<u>990.201</u>	<u>995.9</u>
Final Reference Meter	<u>990.109</u>	<u>995.804</u>	<u>1003.2</u>
Initial DGM	<u>0</u>	<u>0</u>	<u>0</u>
Final DGM	<u>6.684</u>	<u>5.539</u>	<u>7.299</u>
Temp. Ref. Meter (°F), Tr	<u>64.7</u>	<u>64.9</u>	<u>65.9</u>
Temperature DGM (°F), Td	<u>73.0</u>	<u>74.0</u>	<u>76.0</u>
Time (min)	<u>34.0</u>	<u>34.5</u>	<u>52.5</u>
Net Volume Ref. Meter, Vr	6.809	5.603	7.300
Net Volume DGM, Vd	6.684	5.539	7.299
<b>Gas Meter y Factor =</b>	<b>1.028</b>	<b>1.024</b>	<b>1.015</b>
<b>Gas Meter y Factor Deviation (from avg.)</b>	0.006	0.002	0.007
<b>Orifice dH@</b>	N/A	N/A	N/A
<b>Orifice dH@ Deviation (from avg.)</b>	N/A	N/A	N/A

where:

1. Deviation = |Average value for all runs - current run value|
- \*\* 2.  $y = [Vr \times (y \text{ factor (ref)}) \times (Pb + (Pr / 13.6)) \times (Td + 460)] / [Vd \times (Pb + (Pd / 13.6)) \times (Tr + 460)]$
- \*\* 3.  $dH@ = 0.0317 \times Pd / (Pb (Td + 460)) \times [(Tr + 460) \times \text{time}] / Vr ]^2$

\* Reference calibration is traceable to NIST through NIST Test # 40674, Kimble ASTM E1272, or NIST traceable laboratory

\*\* Equations come from EPA Method 5

The uncertainty of measurement is  $\pm 0.14 \text{ ft}^3/\text{min}$ . This is based on the reference standard having a TAR (Test Accuracy Ratio) of at least 4:1.



## DIFFERENTIAL PRESSURE GAUGE CALIBRATION DATA SHEET

Instrument to be calibrated: Pressure Transducer

Maximum Range: 0-2" WC ID Number: OMNI-00335

Calibration Instrument: Digital Manometer ID Number: OMNI-00395

Date: 1/21/19 By: B. Davis

**This form is to be used only in conjunction with Standard Procedure C-SPC.**

Range of Calibration Point ("WC)	Digital Manometer Input ("WC)	Pressure Gauge Response ("WC)	Difference (Input - Response)	% Error of Full Span*
0-20% Max. Range 0 - 0.4	0.070	0.074	0.004	0.2
20-40% Max. Range 0.4 - 0.8	0.620	0.620	0.000	0.0
40-60% Max. Range 0.8 - 1.2	0.980	0.977	0.003	0.15
60-80% Max. Range 1.2 - 1.6	1.277	1.273	0.004	0.2
80-100% Max. Range 1.6 - 2.0	1.716	1.714	0.002	0.1

\*Acceptable tolerance is 4%.

The uncertainty of measurement is  $\pm 0.4$ " WC. This is based on the reference standard having a TAR (Test Accuracy Ratio) of at least 4:1.

Technician signature:  Date: 1/21/2019

Reviewed by:  Date: 2/25/2019

Temperature Calibration EPA Method 28R, ASTM 2515								
BOOTH:		TEMPERATURE MONITOR TYPE:				EQUIPMENT NUMBER:		
Mobile		National Instruments Logger				00335, 00336		
REFERENCE METER EQUIPMENT NUMBER: 00373				Calibration Due Date: 8/02/17				
CALIBRATION PERFORMED BY:			DATE:		AMBIENT TEMPERATURE:		BAROMETRIC PRESSURE:	
B. Davis			1/21/19		67		30.38	
Input Temperature (F)	Ambient	Meter A					Tunnel	FB Interior
			Meter B	Filter A	Filter B			
0	∅	1	∅	1	∅	∅	∅	
100	100	100	100	100	100	100	100	
300	300	300	300	300	300	300	300	
500	500	500	500	500	500	500	500	
700	700	700	700	700	700	700	700	
1000	1000	1000	1000	1000	1000	1000	1000	

Input (F)	FB Top	FB Bottom	FB Back	FB Left	FB Right	Imp A	Imp B	Cat	Stack
0	∅	∅	∅	∅	∅	1	∅	1	∅
100	100	100	100	100	100	100	100	100	100
300	300	300	300	300	300	300	300	300	300
500	500	500	500	500	500	500	500	500	500
700	700	700	700	700	700	700	700	700	700
1000	1000	1000	1000	1000	1000	1000	1000	1000	1000

Technician signature:  Date: 1/21/19

Reviewed By:  Date: 2/25/2019

# Thermal Metering System Calibration Y Factor

Manufacturer: APEX  
 Model: XC-60-EP  
 Serial Number: 606002  
 OMNI Tracking No.: OMNI-00336  
 Calibrated Orifice:  Yes

<b>Average Gas Meter y Factor</b>
<b>0.995</b>

<b>Orifice Meter dH@</b>
<b>N/A</b>

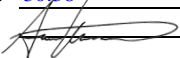
Calibration Date: 1/21/019  
 Calibrated by: B. Davis  
 Calibration Frequency: Six months  
 Next Calibration Due: 7/21/2019  
 Instrument Range: 1.000 cfm  
 Standard Temp.: 68 oF  
 Standard Press.: 29.92 "Hg  
 Barometric Press., Pb: 30.38 "Hg  
 Signature/Date:  1/17/2018

### Previous Calibration Comparison

Date	<u>1/17/2018</u>	Acceptable Deviation (5%)	Deviation
y Factor	<u>0.985</u>	0.04925	0.010
Acceptance	<b>Acceptable</b>		

### Current Calibration

Acceptable y Deviation	0.020
Maximum y Deviation	0.005
Acceptable dH@ Deviation	N/A
Maximum dH@ Deviation	N/A
Acceptance	<b>Acceptable</b>

### Reference Standard \*

Standard Calibrator	Model	Standard Test Meter
	S/N	<u>OMNI-00001</u>
	Calib. Date	<u>14-Nov-18</u>
	Calib. Value	<u>0.9981</u> y factor (ref)

Calibration Parameters	Run 1	Run 2	Run 3
Reference Meter Pressure ("H2O), Pr	0.00	0.00	0.00
DGM Pressure ("H2O), Pd	1.94	1.20	0.80
Initial Reference Meter	6.1	13.7	19.402
Final Reference Meter	13.503	19.3	25
Initial DGM	0	0	0
Final DGM	7.525	5.699	5.746
Temp. Ref. Meter (°F), Tr	67.6	68.3	69.3
Temperature DGM (°F), Td	78.0	79.0	80.0
Time (min)	35.3	32.5	39.5
Net Volume Ref. Meter, Vr	7.403	5.600	5.598
Net Volume DGM, Vd	7.525	5.699	5.746
<b>Gas Meter y Factor =</b>	<b>0.997</b>	<b>0.998</b>	<b>0.990</b>
<b>Gas Meter y Factor Deviation (from avg.)</b>	0.002	0.003	0.005
<b>Orifice dH@</b>	N/A	N/A	N/A
<b>Orifice dH@ Deviation (from avg.)</b>	N/A	N/A	N/A

where:

1. Deviation = |Average value for all runs - current run value|
- \*\* 2.  $y = [Vr \times (y \text{ factor (ref)}) \times (Pb + (Pr / 13.6)) \times (Td + 460)] / [Vd \times (Pb + (Pd / 13.6)) \times (Tr + 460)]$
- \*\* 3.  $dH@ = 0.0317 \times Pd / (Pb (Td + 460)) \times [(Tr + 460) \times \text{time}] / Vr ]^2$

\* Reference calibration is traceable to NIST through NIST Test # 40674, Kimble ASTM E1272, or NIST traceable laboratory

\*\* Equations come from EPA Method 5

The uncertainty of measurement is  $\pm 0.14 \text{ ft}^3/\text{min}$ . This is based on the reference standard having a TAR (Test Accuracy Ratio) of at least 4:1.

## DIFFERENTIAL PRESSURE GAUGE CALIBRATION DATA SHEET

Instrument to be calibrated: Pressure Transducer

Maximum Range: 0-2" WC ID Number: OMNI-00336

Calibration Instrument: Digital Manometer ID Number: OMNI-00395

Date: 1/21/19 By: B. Davis

**This form is to be used only in conjunction with Standard Procedure C-SPC.**

Range of Calibration Point ("WC)	Digital Manometer Input ("WC)	Pressure Gauge Response ("WC)	Difference (Input - Response)	% Error of Full Span*
0-20% Max. Range 0 - 0.4	0.079	0.078	.001	0.05
20-40% Max. Range 0.4 - 0.8	0.762	0.766	.004	0.2
40-60% Max. Range 0.8 - 1.2	0.943	0.949	.006	0.3
60-80% Max. Range 1.2 - 1.6	1.435	1.440	.005	0.25
80-100% Max. Range 1.6 - 2.0	1.644	1.650	.006	0.3

\*Acceptable tolerance is 4%.

The uncertainty of measurement is  $\pm 0.4$ " WC. This is based on the reference standard having a TAR (Test Accuracy Ratio) of at least 4:1.

Technician signature:  Date: 1/21/2019

Reviewed by:  Date: 2/25/2019

Temperature Calibration EPA Method 28R, ASTM 2515								
BOOTH:	TEMPERATURE MONITOR TYPE:				EQUIPMENT NUMBER:			
Mobile	National Instruments Logger				00335, 00336			
REFERENCE METER EQUIPMENT NUMBER: 00373				Calibration Due Date: 8/02/17				
CALIBRATION PERFORMED BY:			DATE:	AMBIENT TEMPERATURE:		BAROMETRIC PRESSURE:		
B. Davis			1/21/19	67		30.38		
Input Temperature (F)	Ambient	Meter A					Tunnel	FB Interior
			Meter B	Filter A	Filter B			
0	∅	1	∅	1	∅	∅	∅	
100	100	100	100	100	100	100	100	
300	300	300	300	300	300	300	300	
500	500	500	500	500	500	500	500	
700	700	700	700	700	700	700	700	
1000	1000	1000	1000	1000	1000	1000	1000	

Input (F)	FB Top	FB Bottom	FB Back	FB Left	FB Right	Imp A	Imp B	Cat	Stack
0	∅	∅	∅	∅	∅	1	∅	1	∅
100	100	100	100	100	100	100	100	100	100
300	300	300	300	300	300	300	300	300	300
500	500	500	500	500	500	500	500	500	500
700	700	700	700	700	700	700	700	700	700
1000	1000	1000	1000	1000	1000	1000	1000	1000	1000

Technician signature:  Date: 1/21/19

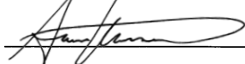
Reviewed By:  Date: 2/25/2019

# Certificate of Calibration

Certificate Number: **686722**



**JJ Calibrations, Inc.**  
 7007 SE Lake Rd  
 Portland, OR 97267-2105  
 Phone 503.786.3005  
 FAX 503.786.2994

**Omni-Test Laboratories**  
 13327 NE Airport Way  
 Portland, OR 97230



PO: **180192**  
 Order Date: **10/22/2018**  
 Authorized By: **N/A**  
 Calibrated on: **10/30/2018**  
 \*Recommended Due: **10/30/2019**  
 Environment: **22 °C 44 % RH**  
 \* As Received: **Limited**  
 \* As Returned: **Limited**  
 Action Taken: **Calibrated**  
 Technician: **111**

Property #: **OMNI-00410**  
 User: **N/A**  
 Department: **N/A**  
 Make: **Dwyer**  
 Model: **1430**  
 Serial #: **OMNI-00410**  
 Description: **Microtector**  
 Procedure: **DCN 500908**  
 Accuracy: **±0.00025" WC**

Remarks: \* Many factors may cause the unit to drift out of calibration before the recommended due date. Any reported error is the absolute value between the reference and the unit. Uncertainties include the effects of the unit.

Previous limitation of micrometer head calibrated only continued. .001" reading micrometer head ±.001" (LSD) tolerance applied.

### Standards Used

Std ID	Manufacturer	Model	Nomenclature	Due Date	Trace ID
541A	Select	E8FED2	Gage Block Set, 8pc	12/18/2018	663864

### Measurement Data

Parameter	Measurement Description	Range	Unit	Reference	Min	Max	*Error	UUT	Uncertainty
<b>Before/After Length</b>									Accredited = ✓
		Inch		0.1300	0.129	0.131	0.001	0.129 Inch	1.1E-03 ✓
		Inch		0.3850	0.384	0.386	0.001	0.384 Inch	1.1E-03 ✓
		Inch		0.6150	0.614	0.616	0.001	0.614 Inch	1.1E-03 ✓
		Inch		0.8700	0.869	0.871	0.001	0.869 Inch	1.1E-03 ✓
		Inch		1.0000	0.999	1.001	0.001	0.999 Inch	1.1E-03 ✓

JJ Calibrations, Inc. certifies that this instrument has been calibrated in accordance with the JJ Calibrations Quality Assurance Manual with the stated procedure using standards that are traceable to the National Institute of Standards and Technology (NIST), or other National Measurement Institutes (NMI's), or by using natural physical constants, intrinsic standards or ratio calibration techniques. The quality system and this certificate are in compliance with ANSI/NCCL Z540-1-1994, ISO/IEC 17025-2005, ISO 10012-1, the ISO 9000 family and QS 9000. The expanded uncertainties of measurements for this calibration are based upon 95% (2 sigma) confidence limits. Unless otherwise stated, a test accuracy ratio (TAR) of 4:1, if achievable, is maintained. The results reported herein apply only to the calibration of the item described above. This report may not be reproduced, except in full, without prior written consent of JJ Calibrations, Inc.  
 JJ Calibrations, Inc. quality system has been assessed and accredited to ISO/IEC 17025:2005.

  
 Reviewer

3 Issued 10/31/2018 Rev # 15

  
 Inspector

# ZRE

# NDIR/O<sub>2</sub>



# USER'S

# MANUAL



1312 West Grove Avenue  
Orange, CA 92865-4134  
Phone: 714-974-5560 Fax: 714-921-2531  
[www.gasanalyzers.com](http://www.gasanalyzers.com)





## VWR Temperature Hygrometer Calibration Procedure and Data Sheet

Frequency: Every Two Years

Step 1: Locate NIST traceable standard.

Step 2: Place unit to be calibrated, tracking No. OMNI-00592, inside OMNI desiccate box on the same shelf with the NIST traceable standard.

Step 3: After a period of not less than four hours record the temperature and humidity of both units in the spaces provide below.

Step 4: If the unit to be calibrated matches the NIST standard within  $\pm 4\%$ , it is acceptable. If not, the unit needs to be sent to a repair company or replaced.

### Verification Data:

Date: 1/29/19  
1/29/19 Technician: B. Davis

Time in desiccate: 0840 Recording time: 1415

NIST Standard Temperature: 70.2 °F NIST Standard Humidity: 14.6

Test Unit Temperature Reading: 69.9 °F Test Unit Humidity Reading: 12.1

Test unit OMNI-00592 is X or was not     within acceptable limits.

Technician Signature: [Signature]

Comments: A difference of 2.5% was found, with a full scale of 90%  
on the instrument this gives a 2.77% deviation.

# Certificate of Calibration

Certificate Number: **692254**



**JJ Calibrations, Inc.**

7007 SE Lake Rd  
Portland, OR 97267-2105  
Phone 503.786.3005  
FAX 503.786.2994

**Omni-Test Laboratories**  
13327 NE Airport Way  
Portland, OR 97230

OnSite

PO: **181203**

Order Date: **01/11/2019**

Authorized By: **N/A**



Calibrated on: **01/11/2019**

\*Recommended Due: **07/11/2019**

Environment: **19 °C 43 % RH**

\* As Received: **Within Tolerance**

\* As Returned: **Within Tolerance**

Action Taken: **Calibrated**

Technician: **123**

Property #: **OMNI-00637**

User: **N/A**

Department: **N/A**

Make: **Mettler Toledo**

Model: **MS104TS/00**

Serial #: **B729400181**

Description: **Analytical Scale, 120g**

Procedure: **DCN 500887**

Accuracy: **±0.0005g**

Remarks: \* Many factors may cause the unit to drift out of calibration before the recommended due date. Any reported error is the absolute value between the reference and the unit. Uncertainties include the effects of the unit.

## Standards Used

Std ID	Manufacturer	Model	Nomenclature	Due Date	Trace ID
256A	Rice Lake	W0133K	Mass Set,	05/30/2019	660578

## Measurement Data

Parameter	Measurement Description	Range	Unit	Reference	Min	Max	*Error	UUT	Uncertainty
Before/After Force									Accredited = U
			g	10.00000	9.9995	10.0005	0.0000	10.0000 g	5.7E-04 U
			g	30.00000	29.9995	30.0005	0.0000	30.0000 g	5.7E-04 U
			g	60.00000	59.9995	60.0005	0.0002	59.9998 g	5.7E-04 U
			g	90.00000	89.9995	90.0005	0.0001	89.9999 g	5.7E-04 U
			g	120.00000	119.9995	120.0005	0.0002	119.9998 g	5.7E-04 U

JJ Calibrations, Inc. certifies that this instrument has been calibrated in accordance with the JJ Calibrations Quality Assurance Manual with the stated procedure using standards that are traceable to the National Institute of Standards and Technology (NIST), or other National Measurement Institutes (NMI's), or by using natural physical constants, intrinsic standards or ratio calibration techniques. The quality system and this certificate are in compliance with ANSI/NCCL Z540-1-1994, ISO/IEC 17025-2005, ISO 10012-1, the ISO 9000 family and QS 9000. The expanded uncertainties of measurements for this calibration are based upon 95% (2 sigma) confidence limits. Unless otherwise stated, a test accuracy ratio (TAR) of 4:1, if achievable, is maintained. The results reported herein apply only to the calibration of the item described above. This report may not be reproduced, except in full, without prior written consent of JJ Calibrations, Inc. JJ Calibrations, Inc. quality system has been assessed and accredited to ISO/IEC 17025:2005.

Reviewer

3 Issued 01/14/2019 Rev # 15

Inspector



# Calibration complies with ISO/IEC 17025, ANSI/NCSL Z540-1, and 9001



Cert. No.: 6530-9263396

## Traceable® Certificate of Calibration for Digital Barometer

Manufactured for and distributed by : Control Company "Drawer 58307,Houston,TX,77258,USA"

### Instrument Identification:

Model: 6530,

S/N: 181062211

Manufacturer: Control Company

### Standards/Equipment:

Description	Serial Number	Due Date	NIST Traceable Reference
Digital Barometer	D4540001	09 Oct 2018	1000415948
Digital Thermometer	130070752	02 Mar 2018	4000-8360837
Chilled Mirror Hygrometer	44654/2H3737	02 Nov 2019	15478
Climate Chamber	W613.0046		

### Certificate Information:

Technician: 57

Procedure: CAL-31

Cal Date: 26 Feb 2018

Cal Due Date: 26 Feb 2020

Test Conditions: 54.9%RH 22.83°C 1023mBar

### Calibration Data: (New Instrument)

Unit(s)	Nominal	As Found	In Tol	Nominal	As Left	In Tol	Min	Max	±U	TUR
%RH	N.A.	N.A.		51.21	52	Y	49	55	0.74	>4:1
°C	N.A.	N.A.		24.55	24.3	Y	24.15	24.96	0.051	>4:1
mb/hPa	N.A.	N.A.		1010.30	1010	Y	1007	1015	0.62	>4:1
mb/hPa	N.A.	N.A.		806.75	806	Y	803	811	0.62	>4:1
mb/hPa	N.A.	N.A.		908.50	908	Y	905	913	0.62	>4:1

This certificate indicates Traceability to standards provided by (NIST) National Institute of Standards and Technology and/or a National Standards Laboratory.

A Test Uncertainty Ratio of at least 4:1 is maintained unless otherwise stated and is calculated using the expanded measurement uncertainty. Uncertainty evaluation includes the instrument under test and is calculated in accordance with the ISO "Guide to the Expression of Uncertainty in Measurement : (GUM). The uncertainty represents an expanded uncertainty using a coverage factor k=2 to approximate a 95% confidence level. In tolerance conditions are based on test results falling within specified limits with no reduction by the uncertainty of the measurement. The results contained herein relate only to the item calibrated. This certificate shall not be reproduced except in full, without written approval of Control Company.

Nominal=Standard's Reading; As Left=Instrument's Reading; In Tol=In Tolerance; Min/Max=Acceptance Range; ± U=Expanded Measurement Uncertainty; TUR=Test Uncertainty Ratio; Accuracy=±(Max-Min)/2; Min=As Left Nominal(Rounded) - Tolerance; Max= As Left Nominal(Rounded) + Tolerance;

Nicol Rodriguez, Quality Manager

Aaron Justice, Technical Manager

### Maintaining Accuracy:

In our opinion once calibrated your Digital Barometer should maintain its accuracy. There is no exact way to determine how long calibration will be maintained. Digital Barometer change little, if any at all, but can be affected by aging, temperature, shock, and contamination.

### Recalibration:

For factory calibration and re-certification traceable to National Institute of Standards and Technology contact Control Company.

CONTROL COMPANY 12554 Galveston RD Suite B230 Webster TX USA 77598  
Phone 281 482-1714 Fax 281 482-9448 sales@control3.com www.control3.com

Control Company is an ISO/IEC 17025:2005 Calibration Laboratory Accredited by (A2LA) American Association for Laboratory Accreditation, Certificate No. 1750.01.  
Control Company is ISO 9001:2008 Quality Certified by DNV GL, Certificate No. CERT-01805-2006-AQ-HOU-RvA.  
International Laboratory Accreditation Cooperation (ILAC) - Multilateral Recognition Arrangement (MRA).

### **3.3 - Example Calculations**

## Equations and Sample Calculations - ASTM E2779 & E2515

Manufacturer:	Hearth & Home
Model:	PS35-C
Run:	2
Category:	Integrated

Equations used to calculate the parameters listed below are described in this appendix. Sample calculations are provided for each equation. The raw data and printout results from a sample run are also provided for comparison to the sample calculations.

$M_{Bdb}$  - Weight of test fuel burned during test run, dry basis, kg

$M_{BSidb}$  - Weight of test fuel burned during test run segment  $i$ , dry basis, kg

BR - Average dry burn rate over full integrated test run, kg/hr

$BR_{Si}$  - Average dry burn rate over test run segment  $i$ , kg/hr

$V_s$  - Average gas velocity in the dilution tunnel, ft/sec

$Q_{sd}$  - Average gas flow rate in dilution tunnel, dscf/hr

$V_{m(std)}$  - Volume of Gas Sampled Corrected to Dry Standard Conditions, dscf

$m_n$  - Total Particulate Matter Collected, mg

$C_s$  - Concentration of particulate matter in tunnel gas, dry basis, corrected to standard conditions, g/dscf

$E_T$  - Total Particulate Emissions, g

PR - Proportional Rate Variation

$PM_R$  - Average particulate emissions for full integrated test run, g/hr

$PM_F$  - Average particulate emission factor for full integrated test run, g/dry kg of fuel burned

## Equations and Sample Calculations - ASTM E2779 & E2515

$M_{Bdb}$  - Weight of test fuel burned during test run, dry basis, kg

ASTM E2779 equation (1)

$$M_{Bdb} = (M_{Swb} - M_{Ewb})(100/(100 + FM))$$

Where,

- FM = average fuel moisture of test fuel, % dry basis
- $M_{Swb}$  = weight of test fuel in hopper at start of test run, wet basis, kg
- $M_{Ewb}$  = weight of test fuel in hopper at end of test run, wet basis, kg

Sample Calculation:

5.63 %

$$M_{Swb} = 36.6 \text{ lbs}$$

$$M_{Ewb} = 21.7 \text{ lbs}$$

0.4536 = Conversion factor from lbs to kg

$$M_{Bdb} = [(36.6 \times 0.4536) - (21.7 \times 0.4536)] (100/(100 + 5.63))$$

$$M_{Bdb} = 6.4 \text{ kg}$$

## Equations and Sample Calculations - ASTM E2779 & E2515

$M_{BSidb}$  - Weight of test fuel burned during test run segment  $i$ , dry basis, kg

ASTM E2779 equation (2)

$$M_{BSidb} = (M_{S_{Siwb}} - M_{E_{Siwb}})(100/(100 + FM))$$

Where,

$M_{S_{Siwb}}$  = weight of test fuel in hopper at start of test run segment  $i$ , wet basis, kg

$M_{E_{Siwb}}$  = weight of test fuel in hopper at end of test run segment  $i$ , wet basis, kg

Sample Calculation (from medium burn rate segment):

$$FM = 5.63 \%$$

$$M_{S_{Siwb}} = 31.3 \text{ lbs}$$

$$M_{E_{Siwb}} = 26.4 \text{ lbs}$$

0.4536 = Conversion factor from lbs to kg

$$M_{BSidb} = [(31.3 \times 0.4536) - (26.4 \times 0.4536)] (100/(100 + 6))$$

$$M_{BSidb} = 2.1 \text{ kg}$$

## Equations and Sample Calculations - ASTM E2779 & E2515

BR - Average dry burn rate over full integrated test run, kg/hr

ASTM E2779 equation (3)

$$BR = \frac{60 M_{Bdb}}{\theta}$$

Where,

$\theta$  = Total length of full intergrated test run, min

Sample Calculation:

$$M_{Bdb} = 6.40 \quad \text{kg}$$

$$\theta = 362 \quad \text{min}$$

$$BR = \frac{60 \times 6.4}{362}$$

$$BR = 1.06 \quad \text{kg/hr}$$



## Equations and Sample Calculations - ASTM E2779 & E2515

$BR_{Si}$  - Average dry burn rate over test run segment  $i$ , kg/hr

ASTM E2779 equation (4)

$$BR_{Si} = \frac{60 M_{BSidb}}{\theta_{Si}}$$

Where,

$$\theta_{Si} = \text{Total length of test run segment } i, \text{ min}$$

Sample Calculation (from medium burn rate segment):

$$M_{BSidb} = 2.10 \text{ kg}$$

$$\theta = 121 \text{ min}$$

$$BR = \frac{60 \times 2.1}{121}$$

$$BR = 1.04 \text{ kg/hr}$$

## Equations and Sample Calculations - ASTM E2779 & E2515

$V_s$  - Average gas velocity in the dilution tunnel, ft/sec

ASTM E2515 equations (9)

$$V_s = F_p \times K_p \times C_p \times (\sqrt{\Delta P})_{avg} \times \sqrt{\frac{T_s}{P_s \times M_s}}$$

Where:

- $F_p$  = djustment factor for center of tunnel pitot tube placement,  $F_p = \frac{V_{strav}}{V_{scent}}$ , ASTM E2515 Equation (1)
- $V_{scent}$  = Dilution tunnel velocity calculated after the multi-point pitot traverse at the center, ft/sec
- $V_{strav}$  = Dilution tunnel velocity calculated after the multi-point pitot traverse, ft/sec
- $k_p$  = Pitot tube constant, 85.49
- $C_p$  = Pitot tube coefficient: 0.99, unitless
- $\Delta P^*$  = Velocity pressure in the dilution tunnel, in H<sub>2</sub>O
- $T_s$  = Absolute average gas temperature in the dilution tunnel, °R; (°R = °F + 460)
- $P_s$  = Absolute average gas static pressure in dilution tunnel, =  $P_{bar} + P_g$ , in Hg
- $P_{bar}$  = Barometric pressure at test site, in. Hg
- $P_g$  = Static pressure of tunnel, in. H<sub>2</sub>O; (in Hg = in H<sub>2</sub>O/13.6)
- $M_s$  = \*\*The dilution tunnel wet molecular weight;  $M_s = 28.78$  assuming a dry weight of 29 lb/lb-mole

Sample calculation:

$$F_p = \frac{13.11}{14.90} = 0.880$$

$$V_s = 0.880 \times 85.49 \times 0.99 \times 0.218 \times \left( \frac{91.4 + 460}{30.07 + \frac{-0.19}{13.6}} \right)^{1/2} \times 28.78$$

$$V_s = 12.95 \text{ ft/s}$$

\*The ASTM test standard mistakenly has the square root of the average delta p instead of the average of the square root of delta p. The current EPA Method 2 is also incorrect. This was verified by Mike Toney at EPA.

\*\*The ASTM test standard mistakenly identifies  $M_s$  as the dry molecular weight. It should be the wet molecular weight as indicated in EPA Method 2.

## Equations and Sample Calculations - ASTM E2779 & E2515

$Q_{sd}$  - Average gas flow rate in dilution tunnel, dscf/hr

ASTM E2515 equation (3)

$$Q_{sd} = 3600 \times (1 - B_{ws}) \times v_s \times A \times \frac{T_{std}}{T_s} \times \frac{P_s}{P_{std}}$$

Where:

3600	=	Conversion from seconds to hours (ASTM method uses 60 to convert in minutes)
$B_{ws}$	=	Water vapor in gas stream, proportion by volume; assume 2%
A	=	Cross sectional area of dilution tunnel, ft <sup>2</sup>
$T_{std}$	=	Standard absolute temperature, 528 °R
$P_s$	=	Absolute average gas static pressure in dilution tunnel, = $P_{bar} + P_g$ , in Hg
$T_s$	=	Absolute average gas temperature in the dilution tunnel, °R; (°R = °F + 460)
$P_{std}$	=	Standard absolute pressure, 29.92 in Hg

Sample calculation:

$$Q_{sd} = 3600 \times (1 - 0.02) \times 12.95 \times 0.1963 \times \frac{528}{91.4 + 460} \times \frac{30.07 + \frac{-0.19}{13.6}}{29.92}$$

$$Q_{sd} = 8628.1 \text{ dscf/hr}$$

## Equations and Sample Calculations - ASTM E2779 & E2515

$V_{m(std)}$  - Volume of Gas Sampled Corrected to Dry Standard Conditions, dscf

ASTM E2515 equation (6)

$$V_{m(std)} = K_1 \times V_m \times Y \times \frac{P_{bar} + \left( \frac{\Delta H}{13.6} \right)}{T_m}$$

Where:

- $K_1$  = 17.64 °R/in. Hg
- $V_m$  = Volume of gas sample measured at the dry gas meter, dcf
- $Y$  = Dry gas meter calibration factor, dimensionless
- $P_{bar}$  = Barometric pressure at the testing site, in. Hg
- $\Delta H$  = Average pressure differential across the orifice meter, in. H<sub>2</sub>O
- $T_m$  = Absolute average dry gas meter temperature, °R

Sample Calculation:

Using equation for Train 1:

$$V_{m(std)} = 17.64 \times 57.531 \times 0.986 \times \frac{\left( 30.07 + \frac{1.32}{13.6} \right)}{\left( 77.9 + 460 \right)}$$

$$V_{m(std)} = \mathbf{56.126} \text{ dscf}$$

Using equation for Train 2:

$$V_{m(std)} = 17.64 \times 57.726 \times 0.985 \times \frac{\left( 30.07 + \frac{1.06}{13.6} \right)}{\left( 78.0 + 460 \right)}$$

$$V_{m(std)} = \mathbf{56.208} \text{ dscf}$$

Using equation for ambient train:

$$V_{m(std)} = 17.64 \times 0.00 \times 0 \times \frac{\left( 30.07 + \frac{0.00}{13.6} \right)}{\left( 67.4 + 460 \right)}$$

$$V_{m(std)} = \mathbf{0.000} \text{ dscf}$$

## Equations and Sample Calculations - ASTM E2779 & E2515

$m_n$  - Total Particulate Matter Collected, mg

ASTM E2515 Equation (12)

$$m_n = m_p + m_f + m_g$$

Where:

$m_p$  = mass of particulate matter from probe, mg

$m_f$  = mass of particulate matter from filters, mg

$m_g$  = mass of particulate matter from filter seals, mg

Sample Calculation:

Using equation for Train 1 (first hour):

$$m_n = 0.0 + 2.2 + 0.0$$

$$m_n = 2.2 \text{ mg}$$

Using equation for Train 1 (remainder):

$$m_n = 0.0 + 5.6 + 0.0$$

$$m_n = 5.6 \text{ mg}$$

Train 1 Aggregate = **7.8 mg**

Using equation for Train 2:

$$m_n = 0.0 + 7.7 + 0.0$$

$$m_n = 7.7 \text{ mg}$$

## Equations and Sample Calculations - ASTM E2779 & E2515

$C_s$  - Concentration of particulate matter in tunnel gas, dry basis, corrected to standard conditions, g/dscf

ASTM E2515 equation (13)

$$C_s = K_2 \times \frac{m_n}{V_{m(\text{std})}}$$

Where:

$K_2$  = Constant, 0.001 g/mg

$m_n$  = Total mass of particulate matter collected in the sampling train, mg

$V_{m(\text{std})}$  = Volume of gas sampled corrected to dry standard conditions, dscf

Sample calculation:

For Train 1:

$$C_s = 0.001 \times \frac{7.8}{56.13}$$

$$C_s = 1.39\text{E-}04 \text{ g/dscf}$$

For Train 2

$$C_s = 0.001 \times \frac{7.7}{56.21}$$

$$C_s = 1.37\text{E-}04 \text{ g/dscf}$$

For Ambient Train

$$C_r = 0.001 \times \frac{0.0}{0.00}$$

$$C_r = 0.000000 \text{ g/dscf}$$

## Equations and Sample Calculations - ASTM E2779 & E2515

$E_T$  - Total Particulate Emissions, g

ASTM E2515 equation (15)

$$E_T = (c_s - c_r) \times Q_{std} \times \theta$$

Where:

- $C_s$  = Concentration of particulate matter in tunnel gas, g/dscf
- $C_r$  = Concentration particulate matter room air, g/dscf
- $Q_{std}$  = Average dilution tunnel gas flow rate, dscf/hr
- $\theta$  = Total time of test run, minutes

Sample calculation:

For Train 1

$$E_T = ( \underline{0.000139} - 0.000000 ) \times \underline{8628.1} \times \underline{362} / 60$$
$$E_T = \underline{7.23} \text{ g}$$

For Train 2

$$E_T = ( \underline{0.000137} - 0.000000 ) \times \underline{8628.1} \times \underline{362} / 60$$
$$E_T = \underline{7.13} \text{ g}$$

Average

$$E = \underline{7.18} \text{ g}$$

Total emission values shall not differ by more than 7.5% from the total average emissions

$$7.5\% \text{ of the average} = \underline{0.54}$$

$$\text{Train 1 difference} = \underline{0.05}$$

$$\text{Train 2 difference} = \underline{0.05}$$

## Equations and Sample Calculations - ASTM E2779 & E2515

### PR - Proportional Rate Variation

ASTM E2515 equation (16)

$$PR = \left[ \frac{\theta \times V_{mi} \times V_s \times T_m \times T_{si}}{\theta_i \times V_m \times V_{si} \times T_{mi} \times T_s} \right] \times 100$$

Where:

- $\theta$  = Total sampling time, min
- $\theta_i$  = Length of recording interval, min
- $V_{mi}$  = Volume of gas sample measured by the dry gas meter during the "ith" time interval, dcf
- $V_m$  = Volume of gas sample as measured by dry gas meter, dcf
- $V_{si}$  = Average gas velocity in the dilution tunnel during the "ith" time interval, ft/sec
- $V_s$  = Average gas velocity in the dilution tunnel, ft/sec
- $T_{mi}$  = Absolute average dry gas meter temperature during the "ith" time interval, °R
- $T_m$  = Absolute average dry gas meter temperature, °R
- $T_{si}$  = Absolute average gas temperature in the dilution tunnel during the "ith" time interval, °R
- $T_s$  = Absolute average gas temperature in the dilution tunnel, °R

Sample calculation (for the first 1 minute interval of Train 1):

$$PR = \left( \frac{362 \times 0.147 \times 12.95 \times (108.0 + 460) \times (77.9 + 460)}{1 \times 57.531 \times 13.09 \times (91.4 + 460) \times (69.0 + 460)} \right) \times 100$$

$$PR = \underline{96} \%$$



## Equations and Sample Calculations - ASTM E2779 & E2515

$PM_R$  - Average particulate emissions for full integrated test run, g/hr

ASTM E2779 equation (5)

$$PM_R = 60 (E_T / \theta)$$

Where,

$E_T$  = Total particulate emissions, grams

$\theta$  = Total length of full integrated test run, min

Sample Calculation:

$$E_T \text{ (Dual train average)} = 7.18 \text{ g}$$

$$\theta = 362 \text{ min}$$

$$PM_R = 60 \times ( 7.18 / 362 )$$

$$PM_R = 1.1905 \text{ g/hr}$$

## Equations and Sample Calculations - ASTM E2779 & E2515

$PM_F$  - Average particulate emission factor for full integrated test run, g/dry kg of fuel burned

ASTM E2779 equation (6)

$$PM_F = E_T / M_{Bdb}$$

Where,

$E_T$  = Total particulate emissions, grams

$M_{Bdb}$  = Weight of test fuel burned during test run, dry basis, kg

Sample Calculation:

$$E_T \text{ (Dual train average)} = 7.18 \text{ g}$$

$$M_{Bdb} = 6.40 \text{ kg}$$

$$PM_F = 7.18 / 6.40 )$$

$$PM_F = 1.12 \text{ g/kg}$$

*Hearth & Home Technologies, LLC  
Model: PS35-C  
Project: 0061PS086E*

# **Appendix A – Labeling & Owner’s Manual**



**CAUTION:** HOT WHILE IN OPERATION DO NOT TOUCH, KEEP CHILDREN AND CLOTHING AWAY. CONTACT MAY CAUSE SKIN BURNS. KEEP FURNISHINGS AND OTHER COMBUSTIBLE MATERIAL FAR AWAY FROM THE APPLIANCE. SEE NAMEPLATE AND INSTRUCTIONS

**ATTENTION:** CHAUD LORS DE L'OPÉRATION. NE PAS TOUCHER. GARDEZ LES ENFANTS ET LES VÊTEMENTS LOIN DE L'ESPACE DÉSIGNÉ DE L'INSTALLATION. LE CONTACT PEUT CAUSER DES BRÛLURES À LA PEAU. GARDEZ LES MEUBLES ET LES MATÉRIAUX COMBUSTIBLES LOIN DE L'ESPACE DÉSIGNÉ DE L'APPAREIL. VOIR L'ÉTIQUETTE ET LES INSTRUCTIONS.



Intertek  
3198406PRT-002



0061PS086E



PS35-C  
PELLET STOVE

Serial No.  
N° de série

HF

BARCODE LABEL

Listed Solid Fuel Room Heater/Pellet Type. Also suitable for Mobile Home Installation. This appliance has been tested and listed for use in Manufactured Homes in accordance with OAR 814-23-9000 through 814-23-909.

Conforms to ASTM STD E1509, Certified to ULC STD S627, ULC/ORD-C1482-M1990 Room Heating Pellet Burning Type, (UM) 84-HUD FOR USE ONLY WITH PELLETIZED WOOD. Do not use any other type of fuel. Intertek-Test Laboratories has determined that this appliance complies with Canadian Standards Association (CSA) B415.1 and Title 40 of the U.S. Code of Federal Regulations, Part 60, SubPart AAA.

Input Rating: 41,900 Btu/s/hr. Electrical Rating: 115 VAC, 60 Hz, Start 3.8 Amps, Run 1.3 AMPS. Route power cord away from unit. Do not route cord under or in front of appliance. Do not obstruct the space beneath the heater.

**DANGER:** Risk of electrical shock. Disconnect power supply before servicing. Replace glass only with 5mm ceramic available from your dealer. To start, set thermostat above room temperature, the stove will light automatically. To shutdown, set thermostat to below room temperature. For further instruction refer to owner's manual. Keep viewing and ash removal doors tightly closed during operation.

**PREVENT HOUSE FIRES**

Install and use only in accordance with manufacturer's installation and operating instructions. Contact local building or fire officials about restrictions and inspection in our area.

**WARNING - FOR MOBILE HOMES:** Do not install appliance in a sleeping room. An outside combustion air inlet must be provided. The structural integrity of the mobile home floor, ceiling and walls must be maintained.

Refer to manufacturer's instructions and local codes for precautions required for passing chimney through a combustible wall or ceiling. Inspect and clean vent system frequently in accordance with manufacturer's instructions.

DO NOT CONNECT THIS UNIT TO A CHIMNEY SERVING ANOTHER APPLIANCE.

Use a 3" or 4" diameter type "L" or "PL" venting system.

Appareil de chauffage de combustible solide/de type de boulettes. Appareil dans l'installation dans les maisons mobiles. Cet appareil a été testé et enregistré pour l'usage dans les Maisons Mobiles en accord avec OAR 814-23-9000 jusqu'à 814-23-909.

Testé à: ASTM E1509-04, ULC S627-00, ULC/ORD-C1482-M1990 Room Heating, Pellet Burning Type, (UM) 84-HUD POUR USAGE AVEC LES BOULETTES DE BOIS. N'utiliser aucun autre genre de combustible. Intertek Test Laboratories a déterminé que cet appareil se conforme avec la norme de l'Association Canadienne de normalisation (CSA) B415.1 ainsi que le Titre 40 du Code Fédéral de Régulations des États-Unis, partie 60, sous-partie AAA.

Puissance de Rendement: 41 900 Btu/s/hr. Puissance Électrique: 115 VAC, 60 Hz, Début 3.8 Amps, Courir 1.3 Amps. Éloignez le fil électrique de l'appareil. Ne pas faire passer le fil électrique au dessus ou en dessous de l'appareil. Ne pas bloquer l'espace au dessous de l'appareil.

**DANGER:** Il y a risque de décharge électrique. Déconnectez le fil électrique de la prise de contact avant le service. Remplacez la vitre seulement avec une vitre céramique de 5 mm disponible chez votre fournisseur. Pour allumer, monter la température du thermostat au dessus de la température de la pièce, le poêle s'allumera automatiquement. Pour éteindre, descendre la température du thermostat en dessous de la température de la pièce. Pour des instructions supplémentaires, référez vous au manuel du propriétaire. Gardez la porte d'ouverture et la porte des cendres fermées hermétiquement durant l'opération.

**PRÉVENTION DES FEUX DE MAISON**

Installez et utilisez en accord avec les instructions d'installation et d'opération du fabricant. Contactez le bureau de la construction ou le bureau des incendies au sujet des restrictions et des inspections d'installation dans votre voisinage. Ne pas obstruez l'espace en dessous de l'appareil.

**AVIS - Pour Les Maisons Mobiles:** Ne pas installer dans une chambre à coucher. Un tuyau extérieur de combustion d'air doit être installé et ne doit pas être obstrué lorsque l'appareil est en usage. La structure intégrale du plancher, du plafond et des murs de la maison mobile doit être maintenue intacte.

Référez vous aux instructions du fabricant et des codes locaux pour les précautions requises pour passer une cheminée à travers un mur ou un plafond combustibles, et les compensations maximums. Inspectez et nettoyez la cheminée fréquemment. Ne pas connecter cet appareil à une cheminée servant un autre appareil. Utilisez système de ventilation "L" ou "P" diamètre 76mm ou 102mm

**MINIMUM CLEARANCES TO COMBUSTIBLE MATERIALS / ESPACES LIBRES MINIMUM DES MATÉRIAUX COMBUSTIBLES:**

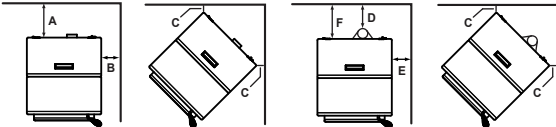

- A Back Wall / Mur Arrière 2 in [51mm]
- B Side Wall / Mur De Côté 14 in [356mm]

**CORNER INSTALLATION / INSTALLATION DU COIN :**

- C Side Wall / Mur De Côté 2 in [51mm]

**VERTICAL 3 in. - 3 in. ADAPTER KIT (PART 811-0860) INSTALLATION:**

**UN ASSEMBLAGE POUR ADAPTEUR 3-3 in (76-76mm) (PIÈCE 811-0860) POUR INSTALLATION VERTICALE:**

- D Pipe to Back Wall / Un Tuyau Mur Arrière 1 in [25mm]
- E Side Wall / Mur De Côté 14 in [356mm]
- F Back Wall / Mur Arrière 6.25 in [159mm]

**CORNER INSTALLATION WITH VERTICAL ADAPTER KIT:**

**INSTALLATION DU COIN AVEC UN ASSEMBLAGE D'ADAPTEUR VERTICAL:**

- G Side Wall / Mur De Côté 2 in [51mm]

**ALCOVE INSTALLATION / INSTALLATION DE L'ALCÔVE:**

- Min. Alcove Height: / Une hauteur minimum de l'alcôve 51.75 in [1341mm]
- Min. Alcove Side Wall: / Une hauteur minimum mur de côté de l'alcôve 14 in [356mm]
- Min. Alcove Width / Une épaisseur minimum mur de côté de l'alcôve 50.25 in [1276mm]
- Max. Alcove Depth: / La profondeur maximum de l'alcôve 48 in [1219mm]
- Max. Mantle Depth: / Profondeur maximum de la manteau de cheminée 36 in [914mm]
- Top of Unit to Combustibles: / Vue du haut des matériaux combustibles 21 in [533mm]

**NOTE 1:** In residential installations, when using Parts 811-0860, (3" - 3" Top Vent Adapter) and 812-3570 (3" - 6" Offset Adapter), 24 gauge 6" single wall flue connector may be used.

**NOTE 1:** Dans les installations résidentielles, lorsque les pièces 811-0860, (dessus de l'adaptateur de ventilation 3" - 3") et 812-3570 (le ressaut de l'adaptateur 3" - 6"), un tuyau connecteur de 6" pour mur simple de calibre 24 peut être utilisé.

**NOTE 2:** In manufactured home installation, when using Part 811-0860, (3" - 3" Top Vent Adapter) and 812-3570 (3" - 6" Offset Adapter), use listed double wall flue connector. An Outside Air Kit (Part 811-0872), must be used with manufactured home installation.

**NOTE 2:** Pour l'installation dans les maisons préfabriquées, lorsque les pièces 811-0860, (dessus de l'adaptateur de ventilation 3" - 3") et 812-3570 (le ressaut de l'adaptateur 3" - 6"), utilisez un tuyau connecteur enregistré pour mur double. Un assemblage d'air extérieur (Part 811-0872), doit être utilisé pour l'installation dans les maisons préfabriquées.

**FLOOR PROTECTION / PROTECTION DU SOL**

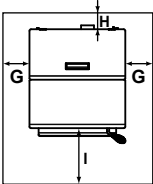

- USA**
- G = 2 in
- H\* = 2 in
- I = 6 in
- CANADA**
- G = 203 mm
- H\* = 51 mm
- I = 152 mm

Floor protector must be non-combustible material, extending beneath heater and to the front/sides/rear as indicated. Measure front distance (I) from the surface of the glass door.

\*Non-combustible floor protection must extend 2 inches (51mm) beneath the flue pipe when installed with horizontal venting or under the Top Vent Adapter with vertical installation.

RECOMMENDED IN USA; REQUIRED IN CANADA.

Le poêle doit être placé sur une assise non combustible s'étendant tout autour de lui, comme les schémas l'indiquent. Mesurez la distance du devant (I) de la surface de la porte vitrée.

\*Un protecteur incombustible de plancher doit s'étendre 2 inches (51mm) sous le conduit de cheminée pour une installation de ventilation horizontale ou sous un adaptateur de ventilation de dessus pour une installation verticale.

ÉTATS-UNIS - RECOMMANDÉ; CANADA - REQUIERT.

Manufactured by: Fabriqué par:

**HEARTH & HOME**  
technologies  
352 Mountain House Road  
Halifax, Pa 17032  
www.heatilator.com

**U.S. ENVIRONMENTAL PROTECTION AGENCY**

Certified to comply with 2020 particulate emission standards at 1.0 g/hr EPA method 28R and ATSM 7279. This wood heater needs periodic inspection and repair for proper operation. Consult the owner's manual for further information. It is against federal regulations to operate this wood heater in a manner inconsistent with the operating instructions in the owner's manual.

2019	2020	2021	JAN	FEB	MAR	APR	MAY	JUN	JUL	AUG	SEP	OCT	NOV	DEC
<input type="checkbox"/>	<input type="checkbox"/>	<input type="checkbox"/>	<input type="checkbox"/>	<input type="checkbox"/>	<input type="checkbox"/>	<input type="checkbox"/>	<input type="checkbox"/>	<input type="checkbox"/>	<input type="checkbox"/>	<input type="checkbox"/>	<input type="checkbox"/>	<input type="checkbox"/>	<input type="checkbox"/>	<input type="checkbox"/>

DO NOT REMOVE THIS LABEL / NE PAS ENLEVER L'ÉTIQUETTE

Made in U.S.A. of US and imported parts. / Fabriqué aux États-Unis-d'Amérique par des pièces d'origine américaine et pièces importées. 7058-802A

# Owner's Manual

## Operation & Care

**INSTALLER:** Leave this manual with party responsible for use and operation.  
**OWNER:** Retain this manual for future reference.

Contact your dealer with questions on installation, operation, or service.

**NOTICE: DO NOT DISCARD THIS MANUAL**

 **heatilator**  
**ECOCHOICE™**  
PELLET BURNING STOVES

**MODEL(S):**  
**PS35-C**

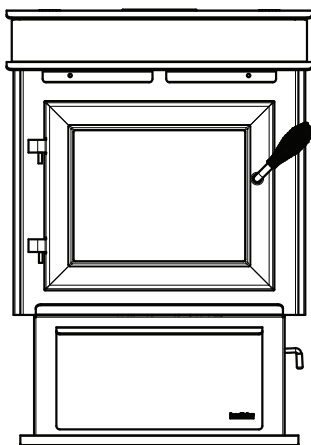

### **WARNING**



If the information in these instructions is not followed exactly, a fire could result causing property damage, personal injury, or death.

- Do not store or use gasoline or other flammable vapors and liquids in the vicinity of this or any other appliance.
- Do not over fire - If appliance or chimney connector glows, you are over firing. Over firing will void your warranty.
- Comply with all minimum clearances to combustibles as specified. Failure to comply may cause house fire.

### **WARNING**



#### **HOT SURFACES!**

Glass and other surfaces are hot during operation AND cool down.  
Hot glass will cause burns.

- Do not touch glass until it is cooled
- NEVER allow children to touch glass
- Keep children away
- CAREFULLY SUPERVISE children in same room as fireplace.
- Alert children and adults to hazards of high temperatures
- **High temperatures may ignite clothing or other flammable materials.**
- Keep clothing, furniture, draperies and other flammable materials away.

### **CAUTION**

**Check building codes prior to installation.**

- Installation MUST comply with local, regional, state and national codes and regulations.
- Consult local building, fire officials or authorities having jurisdiction about restrictions, installation inspection, and permits.

### **CAUTION**

Tested and approved for wood pellets, Burning of any other type of fuel voids your warranty.

Installation and service of this appliance should be performed by qualified personnel. Hearth & Home Technologies recommends HHT Factory Trained or NFI certified professionals.



### **NOTE**

To obtain a French translation of this manual, please contact your dealer or visit [www.heatilatorecochoice.com](http://www.heatilatorecochoice.com).

Pour obtenir une traduction Française de ce manuel, s'il vous plait contacter votre revendeur ou visitez [www.heatilatorecochoice.com](http://www.heatilatorecochoice.com).

# Congratulations

and Welcome to the Heatilator Eco Choice Family!

**NOTE:** Clearances may only be reduced by means approved by the regulatory authority having jurisdiction

## A. Sample of Serial Number / Safety Label

LOCATION: On chain behind right access panel & Behind left access panel

Test Lab and Report Number

**Model Name**

**PS35-C PELLET STOVE**



Intertek  
3198408PRT-002



0061FS068E



PS35-C  
PELLET STOVE

Serial No.  
N° de série

**HF**

**CAUTION:** HOT WHILE IN OPERATION DO NOT TOUCH, KEEP CHILDREN AND CLOTHING AWAY. CONTACT MAY CAUSE SKIN BURNS. KEEP FURNISHINGS AND OTHER COMBUSTIBLE MATERIAL FAR AWAY FROM THE APPLIANCE. SEE NAMEPLATE AND INSTRUCTIONS

**ATTENTION:** CHAUD LORS DE L'OPÉRATION. NE PAS TOUCHER. GARDEZ LES ENFANTS ET LES VÊTEMENTS LOIN DE L'ESPACE DÉSIGNÉ DE L'INSTALLATION. LE CONTACT PEUT CAUSER DES BRÛLURES À LA PEAU. GARDEZ LES MEUBLES ET LES MATÉRIEL COMBUSTIBLES LOIN DE L'ESPACE DÉSIGNÉ DE L'APPAREIL. VOIR L'ÉTIQUETTE ET LES INSTRUCTIONS.

Listed Solid Fuel Room Heater/Pellet Type. / Appareil solide de chauffage à pellets de type de bouillettes. This appliance has been tested and listed for use in Manufactured Homes in accordance with OAR 814-23-9000 through 814-23-909.

Conforms to ASTM E1509, Certified to ULC STD S627, ULC/ORD-C1482-M1990 Room Heating Pellet Burning Type, (UM) 84-HUD FOR USE ONLY WITH PELLETIZED WOOD. Do not use any other type of fuel. Intertek-Test Laboratories has determined that this appliance complies with Canadian Standards Association (CSA) B415.1 and Title 40 of the U.S. Code of Federal Regulations, Part 60, SubPart AAA.

Input Rating 41,900 Btu/hrs; Electrical Rating 115 VAC, 60 Hz, Start 3.8 Amps, Run 1.3 AMPs. Route power cord away from unit. Do not route cord under or in front of appliance. Do not obstruct the space beneath the heater.

**DANGER:** Risk of electrical shock. Disconnect power supply before servicing. Replace glass only with 5mm ceramic available from your dealer. To start, set thermostat above room temperature, the stove will light automatically. To shutdown, set thermostat to below room temperature. For further instruction refer to owner's manual.

Keep viewing and ash removal doors tightly closed during operation.

**PREVENT HOUSE FIRES**

Install and use only in accordance with manufacturer's installation and operating instructions. Contact local building or fire officials about restrictions and inspection in our area.

**WARNING - FOR MOBILE HOMES:** Do not install appliance in a sleeping room. An outside combustion air inlet must be provided. The structural integrity of the mobile home floor, ceiling and walls must be maintained.

Refer to manufacturer's instructions and local codes for precautions required for passing chimney through a combustible wall or ceiling. Inspect and clean vent system frequently in accordance with manufacturer's instructions.

**DO NOT CONNECT THIS UNIT TO A CHIMNEY SERVING ANOTHER APPLIANCE.**

Use a 3" or 4" diameter type "L" or "PL" venting system.

**PREVENTION DES FEUX DE MAISON**

Installez et utilisez en accord avec les instructions d'installation et d'opération du fabricant. Contactez le bureau de la construction ou le bureau des incendies au sujet des restrictions et des inspections d'installation dans votre logement. Ne pas installer dans une chambre à coucher. Un tuyau extérieur de combustion doit être fourni. L'intégrité structurelle du plancher, du plafond et des murs de la maison mobile doit être maintenue intacte.

Référez-vous aux instructions du fabricant et des codes locaux pour les précautions requises pour passer une cheminée à travers un mur ou un plafond combustibles, et les compensations maximums.

**N'ÉTAIS PAS À BRÛLER À UN AUTRE APPAREIL.**

Utilisez un système de ventilation "L" ou "P" diamètre 76mm ou 102mm

**MINIMUM CLEARANCES TO COMBUSTIBLE MATERIALS / ESPACES LIBRES MINIMUM DES MATÉRIEL COMBUSTIBLES:**

A	Back Wall / Mur Arrière	2 in [51mm]
B	Side Wall / Mur De Côté	14 in [356mm]
C	CORNER INSTALLATION / INSTALLATION DU COIN : Side Wall / Mur De Côté	2 in [51mm]
<b>VERTICAL 3 in. - 3 in. ADAPTER KIT (PART 811-0860) INSTALLATION:</b>		
D	UN ASSEMBLAGE POUR ADAPTEUR 3 in (76.2mm) PIÈCE 811-0860 POUR INSTALLATION VERTICALE: Pipe to Back Wall / Un Tuyau Mur Arrière	1 in [25mm]
E	Side Wall / Mur De Côté	14 in [356mm]
F	Back Wall / Mur Arrière	6.25 in [159mm]
<b>CORNER INSTALLATION WITH VERTICAL ADAPTER KIT: INSTALLATION DU COIN AVEC UN ASSEMBLAGE D'ADAPTEUR VERTICAL:</b>		
G	Side Wall / Mur De Côté	2 in [51mm]
<b>ALCOVE INSTALLATION / INSTALLATION DE L'ALCÔVE:</b>		
	Min. Alcove Height / Une hauteur minimum de l'alcove	51.75 in [1314mm]
	Min. Alcove Side Wall / Une hauteur minimum mur de côté de l'alcove	14 in [356mm]
	Min. Alcove Width / Une épaisseur minimum mur de côté de l'alcove	50.25 in [1276mm]
	Max. Alcove Depth / La profondeur maximum de l'alcove	48 in [1219mm]
	Max. Mantle Depth / Profondeur maximum de la manteau de cheminée	36 in [914mm]
	Top of Unit to Combustibles / Vue du haut des matériaux combustibles	21 in [533mm]

**FLOOR PROTECTION / PROTECTION DU SOL**

Floor protector must be non-combustible material, extending beneath heater and to the front/sides/rear as indicated. Measure front distance (I) from the surface of the glass door.

Le poêle doit être placé sur une assise non combustible s'étendant tout autour de lui, comme les schémas l'indiquent. Mesurez la distance du devant (I) de la surface de la porte vitrée.

**USA**  
G = 2 in  
H\* = 2 in  
I = 6 in

**CANADA**  
G = 203 mm  
H\* = 51 mm  
I = 152 mm

\*Non-combustible floor protection must extend 2 inches (51mm) beneath the flue pipe when installed with horizontal venting or under the Top Vent Adapter with vertical installation.

Un protecteur incombustible de plancher doit s'étendre 2 inches (51mm) sous le conduit de cheminée pour une installation de ventilation horizontale ou sous un adaptateur de ventilation de dessus pour une installation verticale.

**RECOMMENDED IN USA; REQUIRED IN CANADA.** / **ÉTATS-UNIS - RECOMMANDÉ; CANADA - REQUIERT.**

Manufactured by: Fabriqué par: HEARTH-C-HOME 352 Mountain House Road Halifax, Pa 17032 www.heatilator.com

U.S. ENVIRONMENTAL PROTECTION AGENCY Certified to comply with 2020 particulate emission standards at 1.0 g/hr EPA method 28R and ATSM 2779. This wood heater meets applicable emissions and must be used in accordance with the owner's manual for proper operation. / Ce poêle à bois répond aux normes d'émissions applicables et doit être utilisé conformément au manuel de l'utilisateur pour une utilisation appropriée.

2019	2020	2021	JAN	FEB	MAR	APR	MAY	JUN	JUL	AUG	SEP	OCT	NOV	DEC
<input type="checkbox"/>	<input type="checkbox"/>	<input type="checkbox"/>	<input type="checkbox"/>	<input type="checkbox"/>	<input type="checkbox"/>	<input type="checkbox"/>	<input type="checkbox"/>	<input type="checkbox"/>	<input type="checkbox"/>	<input type="checkbox"/>	<input type="checkbox"/>	<input type="checkbox"/>	<input type="checkbox"/>	<input type="checkbox"/>

**DO NOT REMOVE THIS LABEL / NE PAS ENLEVER L'ÉTIQUETTE**

7 58-802A

Serial Number

Manufacturer Date

2

7058-801A

March 22, 2019

**Safety Alert Key:**



- **DANGER!** Indicates a hazardous situation which, if not avoided will result in death or serious injury.
- **WARNING!** Indicates a hazardous situation which, if not avoided could result in death or serious injury.
- **CAUTION!** Indicates a hazardous situation which, if not avoided, could result in minor or moderate injury.
- **NOTICE:** Indicates practices which may cause damage to the appliance or to property.

**TABLE OF CONTENTS**

A. Sample of Serial Number / Safety Label . . . . .	2	<b>3 Maintenance and Service . . . . .</b>	<b>15</b>
B. Warranty Policy . . . . .	4	A. Proper Shutdown Procedure . . . . .	15
C. Quick Start Guide . . . . .	6	B. Quick Reference Maintenance Chart . . . . .	15
<b>1 Listing and Code Approvals . . . . .</b>	<b>7</b>	C. General Maintenance . . . . .	16
A. Appliance Certification . . . . .	7	D. High Ash Fuel Content Maintenance. . . . .	20
B. BTU & Efficiency Specifications . . . . .	7	E. Soot or Creosote Fire . . . . .	20
C. Glass Specifications . . . . .	8	<b>4 Troubleshooting Guide . . . . .</b>	<b>21</b>
D. Electrical Rating (on high) . . . . .	8	<b>5 Service Parts Replacement . . . . .</b>	<b>24</b>
E. Mobile Home Approved . . . . .	8	A. Convection Blower Replacement . . . . .	24
F. Sleeping Room . . . . .	8	B. Exhaust Blower Replacement . . . . .	25
G. California - Prop65 . . . . .	8	C. Snap Disc Replacements . . . . .	25
<b>2 Operating Instructions . . . . .</b>	<b>9</b>	D. Igniter Replacement . . . . .	26
A. Fire Safety . . . . .	9	E. Baffle Removal & Replace . . . . .	26
B. Non-Combustible Materials . . . . .	9	F. Glass Replacement . . . . .	27
C. Combustible Materials . . . . .	9	<b>6 Reference Materials . . . . .</b>	<b>28</b>
D. Fuel Material and Fuel Storage . . . . .	9	A. Component Functions . . . . .	28
E. General Operating Information . . . . .	10	B. Component Locations . . . . .	30
F. Before Your First Fire . . . . .	10	C. Maintenance and Service Log . . . . .	31
G. Hopper Lid Latch and Hopper Switch . . . . .	11	D. Exploded Drawing . . . . .	35
H. Starting Your First Fire . . . . .	11	E. Service Parts . . . . .	36
I. Fire Characteristics . . . . .	12	F. Accessories . . . . .	38
J. Feed Rate Adjustment Instructions . . . . .	12		
K. Ignition Cycles . . . . .	12		
L. Clear Space . . . . .	13		
M. Thermostat Operation . . . . .	13		
N. Frequently Asked Questions . . . . .	14		

Heatilator Eco Choice is a registered trademark of Hearth & Home Technologies.

**B. Warranty Policy**

**Hearth & Home Technologies Inc.**

**HEATILATOR ECO-CHOICE WARRANTY**

Hearth & Home Technologies Inc., on behalf of its hearth brands (“HHT”), extends the following warranty for ECO-CHOICE by heatilator wood and pellet hearth appliances that are purchased from an HHT authorized dealer.

**WARRANTY COVERAGE:**

HHT warrants to the original owner of the HHT appliance at the site of installation, and to any transferee taking ownership of the appliance at the site of installation within two years following the date of original purchase, that the HHT appliance will be free from defects in materials and workmanship at the time of manufacture. After installation, if covered components manufactured by HHT are found to be defective in materials or workmanship during the applicable warranty period, HHT will, at its option, repair or replace the covered components. HHT, at its own discretion, may fully discharge all of its obligations under such warranties by replacing the product itself or refunding the verified purchase price of the product itself. The maximum amount recoverable under this warranty is limited to the purchaser price of the product. This warranty is subject to conditions, exclusions and limitations as described below.

**WARRANTY PERIOD:**

Warranty coverage begins on the date of original purchase. In the case of new home construction, warranty coverage begins on the date of first occupancy of the dwelling or six months after the sale of the product by an independent, authorized HHT dealer/distributor, whichever occurs earlier. The warranty shall commence no later than 24 months following the date of product shipment from HHT, regardless of the installation or occupancy date. The warranty period for parts and labor for covered components is produced in the following table.

Warranty Period		Heatilator ECO-CHOICE Appliances		Components Covered
Parts	Labor	Pellet	EPA Wood	
1 year		X	X	All parts and material except as covered by Conditions, Exclusions, and Limitations listed
3 years		X		Firepots and burnpots
3 years	1 year	X	X	Castings
5 years	3 years		X	Manifold tubes
5 years	3 years	X	X	Firebox and heat exchanger
90 days		X	X	All replacement parts beyond warranty period

See conditions, exclusions, and limitations on next page



**WARRANTY COVERAGE:**

- This warranty only covers HHT appliances that are purchased through an HHT authorized dealer or distributor. A list of HHT authorized dealers is available on the HHT branded websites.
- This warranty is only valid while the HHT appliance remains at the site of original installation.
- Contact your installing dealer for warranty service. If the installing dealer is unable to provide necessary parts, contact the nearest HHT authorized dealer or supplier. Additional service fees may apply if you are seeking warranty service from a dealer other than the dealer from whom you originally purchased the product.
- Check with your dealer in advance for any costs to you when arranging a warranty call. Travel and shipping charges for parts are not covered by this warranty.

**WARRANTY EXCLUSIONS:**

This warranty does not cover the following:

- Changes in surface finishes as a result of normal use. As a heating appliance, some changes in color of interior and exterior surface finishes may occur. This is not a flaw and is not covered under warranty.
- Damage to printed, plated, or enameled surfaces caused by fingerprints, accidents, misuse, scratches, melted items, or other external sources and residues left on the plated surfaces from the use of abrasive cleaners or polishes.
- Repair or replacement of parts that are subject to normal wear and tear during the warranty period. These parts include: paint, wood, pellet and coal gaskets; firebricks; grates; flame guides; light bulbs; batteries and the discoloration of glass.
- Minor expansion, contraction, or movement of certain parts causing noise. These conditions are normal and complaints related to this noise are not covered by this warranty.
- Damages resulting from: (1) failure to install, operate, or maintain the appliance in accordance with the installation instructions, operating instructions, and listing agent identification label furnished with the appliance; (2) failure to install the appliance in accordance with local building codes; (3) shipping or improper handling; (4) improper operation, abuse, misuse, continued operation with damaged, corroded or failed components, accident, or improperly/incorrectly performed repairs; (5) environmental conditions, inadequate ventilation, negative pressure, or drafting caused by tightly sealed constructions, insufficient make-up air supply, or handling devices such as exhaust fans or forced air furnaces or other such causes; (6) use of fuels other than those specified in the operating instructions; (7) installation or use of components not supplied with the appliance or any other components not expressly authorized and approved by HHT; (8) modification of the appliance not expressly authorized and approved by HHT in writing; and/or (9) interruptions or fluctuations of electrical power supply to the appliance.
- Non-HHT venting components, hearth components or other accessories used in conjunction with the appliance.
- Any part of a pre-existing fireplace system in which an insert or a decorative gas appliance is installed.
- HHT's obligation under this warranty does not extend to the appliances' capability to heat the desired space. Information is provided to assist the consumer and the dealer in selecting the proper appliance for the application. Consideration must be given to appliance location and configuration, environmental conditions, insulation and air tightness of the structure.

**This warranty is void if:**

- The appliance has been over-fired or operated in atmospheres contaminated by chlorine, fluorine, or other damaging chemicals. Overfiring can be identified by, but not limited to, warped plates or tubes, rust colored cast iron, bubbling, cracking and discoloration of steel or enamel finishes.
- The appliance is subjected to prolonged periods of dampness or condensation.
- There is any damage to the appliance or other components due to water or weather damage which is the result of, but not limited to improper chimney or venting installation.

**WARRANTY EXCLUSIONS:**

- The owner's exclusive remedy and HHT's sole obligation under this warranty, under any other warranty, express or implied, or in contract, tort or otherwise, shall be limited to replacement, repair, or refund, as specified above. In no event will HHT be liable for any incidental or consequential damages caused by defects in the appliance. Some states do not allow exclusions or limitation of incidental or consequential damages, so these limitations may not apply to you. This warranty gives you specific rights; you may also have other rights, which vary from state to state. EXCEPT TO THE EXTENT PROVIDED BY LAW, HHT MAKES NO EXPRESS WARRANTIES OTHER THAN THE WARRANTY SPECIFIED HEREIN. THE DURATION OF ANY IMPLIED WARRANTY IS LIMITED TO DURATION OF THE EXPRESSED WARRANTY SPECIFIED ABOVE.

## C. Quick Start Guide

**ECO CHOICE QUICK START GUIDE**

\*Before you plug in this appliance, follow these instructions\*

Remove hang tags from the door glass. Clean the glass. Remove the hardware pack and dessicant bag from the firebox area before your first fire.

Turn the thermostat to off.

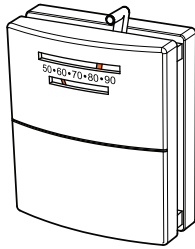
**1**

Add pellets to the hopper and close the lid.

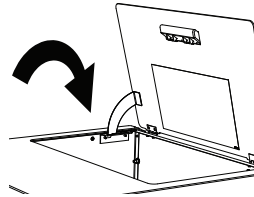
**2**

Open the firebox door and make sure the baffles are in place.

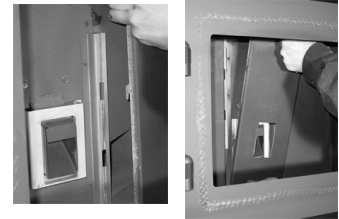
**3**

If the feed tube is empty or this is the first fire, add a handful of pellets to the firepot.

\*Do not add extra fuel to the firepot if the feed tube has already been primed. Overfilling the firepot will cause smoky start-ups.

**4**

Close the firebox door and plug the power cord into the wall receptacle.

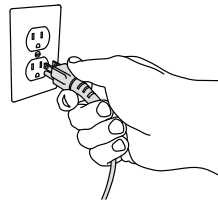
**5**

Turn the thermostat on.

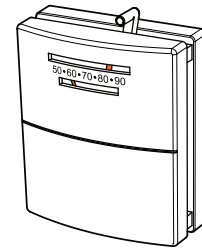
**6**

The stove will feed pellets for a minute and stop. Once a fire starts, the feed cycle will resume.

**Note:** Allow 5 minutes for ignition to take place.

**7**

If the fire dies out after a few minutes of operation it will be necessary to push the reset button to add more fuel.

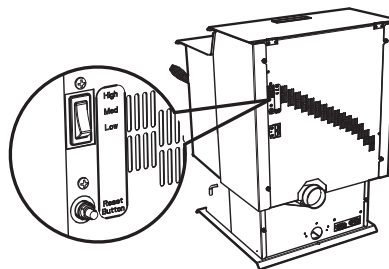
**8**

Once a fire has been established in the unit, leave the unit burning on the "high" setting for 30 minutes to allow the paint to cure.

**Note:** Odors and vapors will be released during this process.

\*Open windows in the room for ventilation\*

**9**

After 30 minutes have passed, turn the thermostat off and allow the unit to cool completely. Open the door and clean the firepot according to the cleaning instructions found inside the hopper lid or owners manual. Close the door and set the thermostat to a desired temperature. Unit is now ready to resume normal operation.

**10**

# 1 Listing and Code Approvals

## A. Appliance Certification

<b>Model</b>	PS35-C
<b>Safety Laboratory</b>	Intertek
<b>Report No.</b>	3198406PRT-002
<b>Type</b>	Solid Fuel Room Heater/Pellet Fuel Burning Type
<b>Standard</b>	ASTM E1509-04 and ULC S627-00, ULC/ORD-C1482-M1990 Room Heater Pellet Fuel Burning type and (UM) 84-HUD, Mobile Home Approved.

## B. BTU & Efficiency Specifications

<b>Emissions Certification #:</b>	0061PS086E
<b>Emissions Laboratory:</b>	OMNI
<b>EPA Certified Emissions:</b>	1.0 grams/hour
<b>*LHV Tested Efficiency:</b>	73.6%
<b>**HHV Tested Efficiency:</b>	68.8%
<b>***EPA BTU Output:</b>	8,600 to 29,700 per hr.
<b>****BTU Input:</b>	12,600 to 41,900 per hr.
<b>Vent Size:</b>	3 or 4 inches, "L" or "PL"
<b>Hopper Capacity:</b>	45 lbs.
<b>Fuel</b>	Premium Wood Pellets
* Weighted average LHV efficiency using data collected during EPA emissions test.	
**Weighted average HHV efficiency using data collected during EPA emissions test.	
***A range of BTU outputs based on EPA Default Efficiency and the burn rates from the low and high EPA tests.	
****Based on the maximum feed rate per hour multiplied by approximately 8,600 BTU's which is the average BTU's from a pound of pellets.	

The PS35 is Certified to comply with 2020 particulate emission standards.



This pellet heater needs periodic inspection and repair for proper operation. It is against federal regulations to operate this pellet heater in a manner inconsistent with operating instructions in this manual.

**NOTICE:** This installation must conform with local codes. In the absence of local codes you must comply with the **ASTM E1509-04, ULC S627-00, (UM) 84-HUD and ULC/ORD-C-1482.**

**C. Glass Specifications**

This appliance is equipped with 5mm ceramic glass. Replace glass only with 5mm ceramic glass. Please contact your dealer for replacement glass.

**D. Electrical Rating (on high)**

115 VAC, 60 Hz, Start 3.8 Amps, Run 1.3 Amp

**E. Mobile Home Approved**

- This appliance is approved for mobile home installations when not installed in a sleeping room and when an outside combustion air inlet is provided.
- The structural integrity of the mobile home floor, ceiling, and walls must be maintained.
- The appliance must be properly grounded to the frame of the mobile home with #8 copper ground wire, and use only listed double-wall connector pipe.
- Outside Air Kit, part 811-0872 or OAK-3 must be installed in a mobile home installation.
- Appliance must be secured to mobile home structure.

**F. Sleeping Room**

When installed in a sleeping room it is recommended that 3ft of vertical be installed prior to horizontally exiting the room and a smoke/CO alarm be installed in the bedroom; The size of the room must be at least 50ft<sup>3</sup> per 1,000 Btu/hr stove input, if the stove exceeds the room size, out air must be installed.

**G. California - Prop65****WARNING**

This product and the fuels used to operate this product (wood), and the products of combustion of such fuels, can expose you to chemicals including carbon black, which is known to the State of California to cause cancer, and carbon monoxide, which is known to the State of California to cause birth defects or other reproductive harm. For more information go to: [WWW.P65Warnings.ca.gov](http://WWW.P65Warnings.ca.gov)

**WARNING****Fire Risk**

Hearth & Home Technologies disclaims any responsibility for, and the warranty will be voided by, the following actions:

- Installation and use of any damaged appliance.
  - Modification of the appliance.
  - Installation other than as instructed by Hearth & Home Technologies.
  - Installation and/or use of any component part not approved by Hearth & Home Technologies.
  - Operating appliance without fully assembling all components.
  - Operating appliance without legs attached (if supplied with appliance).
  - Do NOT Over fire - If appliance or chimney connector glows, you are over firing.
- Any such action that may cause a fire hazard.

Improper installation, adjustment, alteration, service or maintenance can cause injury or property damage.

For assistance or additional information, consult a qualified installer, service agency or your dealer.

**NOTE:** Hearth & Home Technologies, manufacturer of this appliance, reserves the right to alter its products, their specifications and/or price without notice.

Hearth & Home Technologies WILL NOT warranty appliances that exhibit evidence of over-firing. Evidence of over-firing includes, but is not limited to:

- Warped air tube
- Deteriorated refractory brick retainers
- Deteriorated baffle and other interior components

# User Guide

## 2 Operating Instructions



### WARNING



#### Fire Risk.

- Do not operate appliance before reading and understanding operating instructions.
- Failure to operate appliance properly may cause a house fire.

Visit <http://www.heatilator.com/Shopping-Tools/Videos> to view product and use & care videos.

### A. Fire Safety

To provide reasonable fire safety, the following should be given serious consideration:

- Install at least one smoke detector and CO monitor on each floor of your home.
- Locate detectors away from the heating appliance and close to the sleeping areas.
- Follow the detector's manufacturer's placement and installation instructions and maintain regularly.
- A CO detector should be installed in the room with the appliance.
- Conveniently locate a Class A fire extinguisher to contend with small fires.
- In the event of a hopper fire:
  - Evacuate the house immediately.
  - Notify fire department.

### B. Non-Combustible Materials

Material which will not ignite and burn, composed of any combination of the following:

- |           |         |            |         |
|-----------|---------|------------|---------|
| - Steel   | - Brick | - Concrete | - Glass |
| - Plaster | - Iron  | - Tile     | - Slate |

Materials reported as passing **ASTM E 136, Standard Test Method for Behavior of Metals, in a Vertical Tube Furnace of 750° C.**

### C. Combustible Materials

Material made of/or surfaced with any of the following materials:

- |                    |                        |
|--------------------|------------------------|
| - Wood             | - Plastic              |
| - Compressed Paper | - Plywood/OSB          |
| - Plant Fibers     | - Sheet Rock (drywall) |

Any material that can ignite and burn: flame proofed or not, plastered or non-plastered.

### D. Fuel Material and Fuel Storage

Pellet fuel quality can greatly fluctuate. This appliance has been designed to burn a wide variety of fuels, giving you the choice to use the fuel that is most economical in your region.

Hearth & Home Technologies strongly recommends only using Pellet Fuel Institute (PFI) certified fuel.

### Fuel Material

- Made from sawdust or wood by-products
- Depending on the source material it may have a high or low ash content.

### Higher Ash Content Material

- Hardwoods with a high mineral content
- Fuel that contains bark
- Standard grade pellets, high ash pellets,

### Lower Ash Content Material

- Softwoods
- Fuels with low mineral content
- Premium grade pellets



### CAUTION

**Do not burn fuel that contains an additive; (such as soybean oil).**

- May cause hopper fires
  - Damage to product may result
- Read the ingredients list on the package. If you are buying corn the only ingredient that should be listed is corn.

### Clinkers

Minerals and other non-combustible materials such as sand will turn into a hard, glass-like substance called a clinker when heated in the fire pot.

Trees from different areas will vary in mineral content. That is why some fuels produce more clinkers than others.

### Moisture

Always burn dry fuel. Burning fuel with high moisture content takes heat from the fuel and tends to cool the appliance, robbing heat from your home. Damp pellet fuel can clog the feed system.

### Size

- Pellets are either 1/4 inch or 5/16 inch (6-8mm) in diameter
- Length should be no more than 1-1/2 inches (38mm)
- Pellet lengths can vary from lot to lot from the same manufacturer
- Due to length variations, the flame height (feed rate) may need adjusting occasionally. See page 10 for instructions.

### Performance

- Higher ash content requires the ash drawer to be emptied more frequently
- Hardwoods require more air to burn properly
- Set wall control to “Utility Pellet” if the firepot and ash pan are filling quickly. This will cause the auto-clean system to empty the firepot more often.
- Premium wood pellets produce the highest heat output.
- Burning pellets longer than 1-1/2 inches (38mm) can cause an inconsistent fuel feed rate and/or missed ignitions.

We recommend that you buy fuel in multi-ton lots whenever possible. However, we do recommend trying various brands before purchasing multi-ton lots to ensure your satisfaction.

### Changing to Different Fuel Type

- Empty the hopper of the previous fuel
- Thoroughly vacuum hopper before filling with the new fuel
- Select the appropriate setting on the FUEL SELECTION screen on the thermostat wall control

The burn rate, BTU content and heat output will all vary depending on the fuel selected.



### CAUTION

Tested and approved for wood pellets. Burning of any other type of fuel voids your warranty.

### Storage

- Wood pellets should be left in their original sealed bag until using to prevent moisture absorption.
- This will also prevent rodents from becoming a problem.
- Do not store any pellet fuel within the clearance requirements or in an area that would hinder routine cleaning and maintenance.

## E. General Operating Information

### 1. Thermostat Calls For Heat

The appliance is like most modern furnaces; when the thermostat calls for heat, your appliance will automatically light and deliver heat. When the room is up to temperature and the thermostat is satisfied, the red call light will shut off and the appliance will shut down. The red call light is located behind the left access panel.

### 2. Heat Output Controls

This appliance is equipped with a heat output control switch that has three settings or burn rates; low, medium and high (**Figure 10.1**). The appliance will turn on and off as the thermostat demands. When the thermostat calls for heat, the appliance will always start up on High. After burning approximately 4 minutes, the appliance will then burn at the rate at which it was originally set. If the appliance is set at one of the lower settings, it will run quieter but takes longer to heat up an area than if it were set at a higher burn rate. Regardless of the burn rate, when the area is warm enough to satisfy the thermostat, the appliance will shut off.

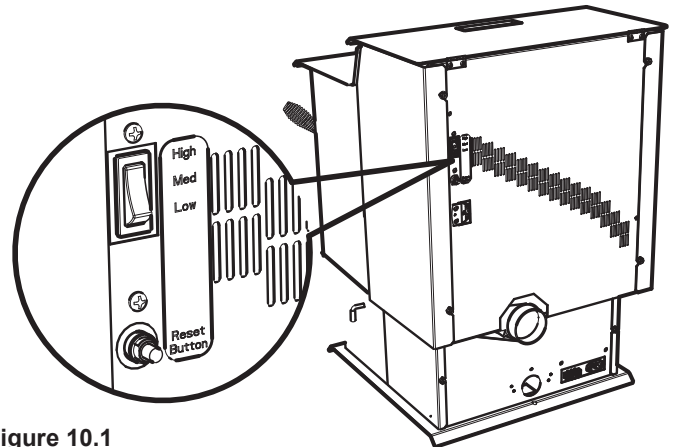

Figure 10.1

## F. Before Your First Fire

1. First, make sure your appliance has been properly installed and that all safety requirements have been met. Pay particular attention to the fire protection, venting and thermostat installation instructions.
2. Double check that the ash drawer and firebox are empty!
3. Check that cleaning rod is in the fully closed position.
4. Close and latch the door.

### CAUTION

Tip of thermocouple must be in contact with the inside end of the thermocouple cover.  
Missed ignitions can occur.

### CAUTION

HOT WHILE IN OPERATION. KEEP CHILDREN, CLOTHING AND FURNITURE AWAY. CONTACT MAY CAUSE SKIN BURNS.

## G. Hopper Lid Latch and Hopper Switch

1. Lift up the hopper lid and lock into open position. Now you can fill the hopper with fuel.
2. The hopper switch is designed to shut down the feed motor when the hopper lid is open. Leaving the lid open too long can cause the fire to go out (**Figure 11.1**).
3. To close the hopper lid, while holding lid open with one hand, push the bottom of the latch inwards to release from locked position and then slowly close the hopper lid (**Figure 11.2**).

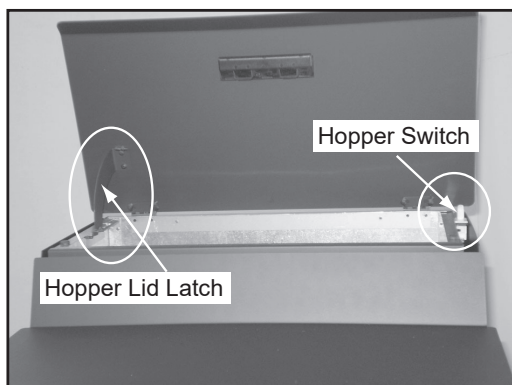

Figure 11.1

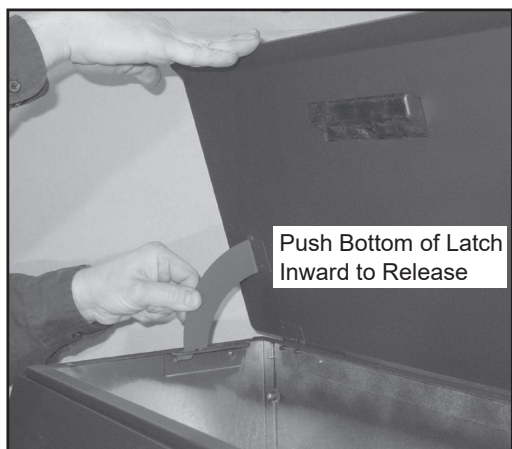

Figure 11.2

## H. Starting Your First Fire

1. A thermostat is required for proper operation of this appliance. If you have to adjust the feed rate after you have started the fire, most of the pellets in the hopper will need to be removed so start out with filling the hopper approximately 1/4 full at this time. Set the thermostat to its lowest setting and plug the power cord into nearby outlet.
2. The exhaust blower will stay on for approximately 18 minutes even though the thermostat is not calling for heat. This is normal.
3. Locate the heat output control switch mounted on the back of the appliance in the upper left corner (**Figure 10.1 on page 10**).
4. Turn it to the "high" setting by pushing the top of the control switch in and then adjust the thermostat to its highest setting.

5. Look through the hole in the left lower side panel and you will see the red call light on the control box will be on (**Figure 11.3**). This indicates the thermostat is calling for heat. On the
6. The fuel feed system and the igniter should now be on.
7. For your first fire it will be necessary to press the reset button once approximately 2 minutes after start up and again in 5 minutes. Reset as needed or every 60 seconds until pellets begin to drop into firepot. This will fill the feed system and allow the appliance to begin dropping pellets. Or you can put a handful of pellets in the firepot to speed up the process. The appliance will continue to run as long as the thermostat is calling for heat.
8. Once the appliance has ignited, let it burn for approximately 15 minutes, then set the thermostat to the desired room temperature. Adjust the heat output control switch to the desired setting.



### CAUTION

Odors and vapors released during initial operation.

- Curing of high temperature paint.
- Open windows for air circulation.

Odors may be irritating to sensitive individuals.

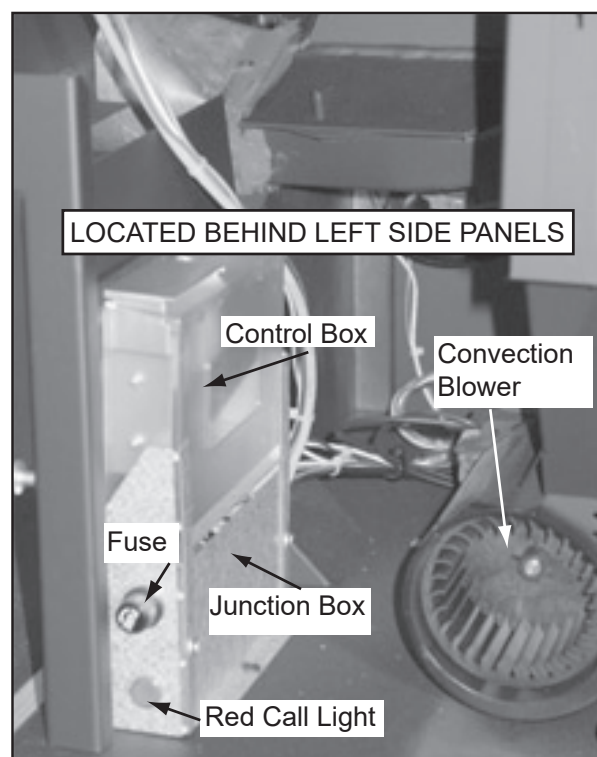

Figure 11.3

## I. Fire Characteristics

A properly adjusted fire with the heat output control switch set on “high” has a short active flame pattern that extends out of the fire pot approximately 4 to 8 inches (102 to 203mm).

If the fire has tall flames with black tails and seems somewhat lazy, the feed rate will need to be reduced. This is done by sliding the fuel adjustment control rod down, which will reduce the feed (**Figure 12.1 & 12.2**).

If the fire is not 4 to 8 inches (102 to 203mm) tall, slide the fuel adjustment control rod up to increase the feed. A medium and low setting will give a shorter flame. The flame will rise and fall somewhat. This is normal.

## J. Feed Rate Adjustment Instructions

1. Loosen the thumb screw.
2. Pull the feed adjustment control rod up to increase the feed rate and flame height or push down to decrease the feed rate and flame height.
3. Re-tighten the thumb screw. A new stove has a break in period. The fire characteristics should be checked again after 5 bags of pellets and adjustments made if necessary.

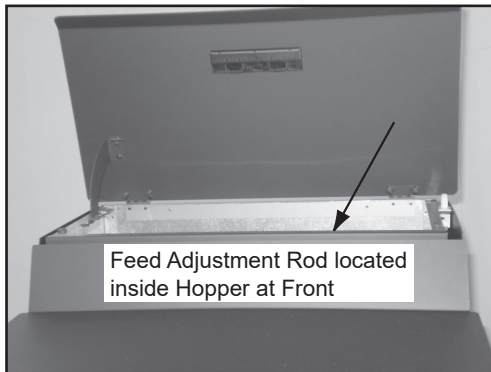

Figure 12.1

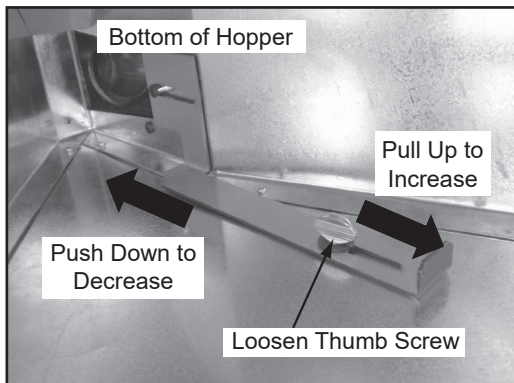

Figure 12.2

## K. Ignition Cycles

1. At the beginning of each ignition cycle, it is normal to see some smoke in the firebox. The smoke will stop once the fire starts.
2. The convection blower will automatically turn on after your appliance has been burning for approximately 10 minutes. This blower transfers heat from your appliance into the room, and will continue to run after the thermostat has stopped calling for heat until the appliance has cooled down.
3. Occasionally the appliance may run out of fuel and shut itself down. When this happens, the red call light will be on (**See Figure 11.3, page 11**).
  - To restart it, fill the hopper and press the reset button. When you press the reset button the red call light will go out. Release the button and the light will come back on. Continue pushing the button once a minute until pellets begin to fall into the fire pot.
  - You should see a fire shortly. If not, follow the instructions on page 9, for “Starting Your First Fire”.



## L. Clear Space

**Mantel:** Avoid placing candles and other heat-sensitive objects on mantel or hearth. Heat may damage these objects.

**NOTICE:** Clearances may only be reduced by means approved by the regulatory authority having jurisdiction.



### WARNING



#### Fire Risk.

Do NOT place combustible objects in front of the appliance. High temperatures may ignite clothing, furniture or draperies. Maintain a minimum clearance of 3 feet (914mm) in front of appliance.



### WARNING



#### Fire Risk.

Keep combustible materials, gasoline and other flammable vapors and liquids clear of appliance.

- Do NOT store flammable materials in the appliance's vicinity.
- **DO NOT USE GASOLINE, LANTERN FUEL, KEROSENE, CHARCOAL LIGHTER FLUID OR SIMILAR LIQUIDS TO START OR "FRESHEN UP" A FIRE IN THIS Appliance.**
- **DO NOT BURN GARBAGE OR FLAMMABLE FLUIDS SUCH AS GASOLINE, NAPHTHA OR ENGINE OIL.**
- **DO NOT USE CHEMICALS OR FLUIDS TO START THE FIRE.**
- Keep all such liquids well away from the appliance while it is in use.
- Combustible materials may ignite.

## M. Thermostat Operation

For accurate temperature control and comfort, correct location is very important. On new installations, the guidelines listed in the installation manual under **Thermostat Installation** should be followed as closely as possible.

To operate the thermostat simple slide the Slide Control that is located at top of thermostat, left or right to adjust the temperature of the room (**Figure 13.1**).

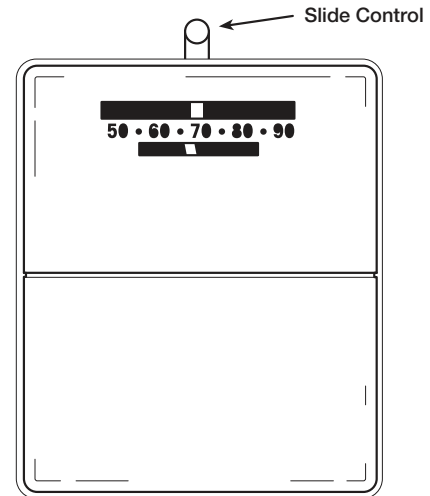

Figure 13.1

**NOTE:** A thermostat can only control temperature near it. If you find that it is uncomfortable some distance away from the thermostat, change the setting in order to compensate for this.

## N. Frequently Asked Questions

### What causes my glass to become dirty?

If the glass has white ash build up it is normal and the glass should be cleaned. If it is a black soot build up airflow through the unit may be restricted. The most often cause is overdue maintenance and cleaning. See "Maintaining and Servicing Appliance" in the owner's manual.

### How can I get more heat out of the appliance?

The most often cause of diminished heat output is overdue maintenance and cleaning. See "Maintaining and Servicing Appliance" in the owner's manual. If this still does not help, verify the correct settings for maximum heat output. See "Feed Rate Adjustment" under "Operating Instructions" in the owner's manual.

### What should I do if I smell smoke or there is ash/soot coming from the appliance?

While there will always be some smoke smell from wood burning appliances (including pellet) you should investigate all venting to make sure it is sealed properly. Most venting requires silicone to seal the seams. In addition most homes are built very tight today and with exhaust systems can create negative pressure in the home. See "Negative Pressure" under "Getting Started" in the owner's manual if you have checked the venting but still have smoke coming from the appliance. For ash or soot check the above and the exhaust blower housing and seals.

### Why would my appliance run fine last winter but not start this fall?

It is possible that the stove was not properly prepared for the Non-burn season. See "Trouble shooting" in the owner's manual.

### Why would the metal on the inside of the appliance begin to flake?

There are some pellet mills that get their raw materials from lumber mills that purchase logs that are transported in sea water. These pellets can have a higher salt content and cause the metals in the unit to corrode prematurely and deteriorate. If you are seeing any components inside the firebox deteriorate it is recommended to change pellet brands immediately.

### Why does only the exhaust blower run when I unplug and plug back in my appliance?

This is a Safety feature to prevent the unit from operating in an unsafe condition. Allow the unit to run and it will return to normal operation.

### Is there a place to lubricate the blowers to quiet them down?

The most often cause of noisy blowers is from the impellers becoming dirty over time. See "General Maintenance & Cleaning" under "Maintaining & Servicing Appliance" in the owner's manual. No form of lubrication should ever need applied to the blowers.

### Why are different components cycling on and off in my appliance at random?

The selector switch on control box may be on the wrong setting. Refer to the Reference Materials section of our owner's manual for details.

### What is the metal object with the bend in it for that came inside the plastic bag?

It is a clean-out tool used to help clean the fire pot and remove any jams in the rare event they occur in the feed tube.

### Why is there a black residue building up on the outside of my home?

Wind can cause this to happen. If the appliance is operating correctly very little soot should ever exit the termination cap. Also check to be sure the venting is installed per the owner's manual and local codes.

### Do I need an outside air kit?

Outside air is required for mobile home installs and in some jurisdictions. Refer to "Listing & Code Approvals", "Mobile Home Installation" and "Appliance Set-up" owner's manual. Also refer to local building codes.

### I am seeing sparks coming out of my pipe (termination cap) outside is this safe?

This is normal. As long as clearances to combustibles were followed this is safe.

### My unit sounds like a freight train at times what can be done to eliminate this?

This is referred to as Rumbling. Maintenance may be needed see "Maintaining and Servicing appliance" in the owner's manual. Decrease fuel flow see "Feed rate adjustment" under Operating Instructions".

### Why does my unit run fine on high, but shuts down on low and medium?

Maintenance may be needed see "Maintaining and Servicing Appliance" See also "Trouble Shooting".

### Can I use another brand of wall thermostat or remote system?

Yes, any remote/wall thermostat system that does not require power from the appliance should work.

### I have no power to anything. Does this unit have a circuit breaker or fuse or a reset button?

This unit has one serviceable fuse in the junction box and a reset button for the thermostat circuit.

### Can I burn corn in my unit?

Corn is not an approved fuel for the ECO units.

### I'm thinking about going green (solar power) and need to know what the power consumption is on my Unit.

115 VAC, 60 Hz, Start 3.8 Amps, Run 1.3 Amps.

### Where is the serial # of my unit is located?

The serial # is located on the back of the stove.

CONTACT YOUR DEALER for additional information regarding operation and troubleshooting.  
Visit [www.heatilatorechoice.com](http://www.heatilatorechoice.com) to find a dealer.

# 3 Maintenance and Service

When properly maintained, your fireplace will give you many years of trouble-free service. Contact your dealer to answer question regarding proper operation, troubleshooting and service for your appliance. Visit [www.heatilator.com/Owner-Support](http://www.heatilator.com/Owner-Support) to view basic troubleshooting, FAQs, use & care videos. We recommend annual service by a qualified service technician.

## A. Proper Shutdown Procedure

Turn off the thermostat.

This pellet heater has a manufacturer-set minimum low burn rate that must not be altered. It is against federal regulations to alter this setting or otherwise operate this pellet heater in a manner inconsistent with operating instructions in this manual.

Follow the detailed instructions found in this section for each step listed as referenced in the chart below.

## B. Quick Reference Maintenance Chart

Cleaning or Inspection	Frequency		Daily	Weekly	Every 2 Weeks	Monthly	Yearly
Ash Pan - Burning Wood Pellets	Every 5 bags of fuel	OR		X			
Ash Pan - Burning Alternate Fuels	Every 1 bag of fuel	OR	X				
Ash Removal from Firebox	More frequently depending on the fuel type or ash build-up	OR		X			
Blower, Combustion (Exhaust)	More frequently depending on the fuel type	OR					X
Blower, Convection	More frequently depending on the operating environment	OR					X
Door Latch Inspection	Prior to heating season	OR				X	
Firebox - Prepare for Non-Burn Season	At end of heating season	OR					X
Fire pot - Burning Softwood Pellets	Every 5 bags	OR		X			
Fire pot - Burning Hardwood Pellets	Every 3 bags	OR		X			
Glass	When clear view of fire pot becomes obscured	OR		X			
Heat Exchanger & Drop Tube	Every 1 ton of fuel	OR			X		
Hopper	Every 1 ton of fuel or when changing fuel types	OR				X	
Top Vent Adapter	More frequently depending on ash build-up	OR					X
Venting System	More frequently depending on the fuel type	OR					X

### CAUTION

#### Shock and Smoke Hazard



- Turn down thermostat, let appliance completely cool and exhaust blower must be off. Now you can unplug appliance before servicing.
- Smoke spillage into room can occur if appliance is not cool before unplugging.
- Risk of shock if appliance not unplugged before servicing appliance.

**NOTICE:** These are recommendations. Clean more frequently if you encounter heavy build-up of ash at the recommended interval or you see soot coming from the vent. Not properly cleaning your appliance on a regular basis will void your warranty.

## C. General Maintenance

### 1. Types of Fuel

Depending on the type of fuel you are burning will dictate how often you have to clean your fire pot.

If the fuel you are burning has a high dirt or ash content, it may be necessary to clean the fire pot more than once a day.

Dirty fuel will cause clinkers to form in the fire pot. A clinker is formed when dirt, ash or a non-burnable substance is heated to 2000°F (1093°C) and becomes glass-like. See “D” page 17 in this section for more details on fuels with high ash content.

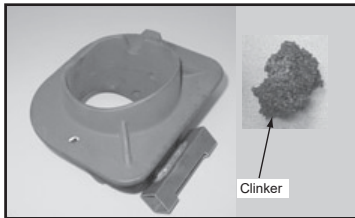
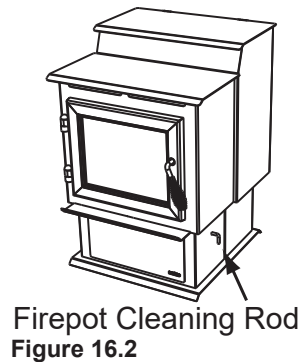

Figure 16.1 - Clinker

### 2. Cleaning Firepot with Cleaning Rod & Firepot Clean-Out Tool

- **Frequency:** Daily or more often as needed
- **By:** Homeowner
  - a. The appliance must be in complete shutdown and cool and the exhaust blower off. If you are just cleaning the firepot, there is no need to unplug the appliance.
  - b. Locate the firepot cleaning rod on the right side of the appliance (**Figure 16.2**). When you pull the cleaning rod straight out it will slide open the firepot floor to allow the ashes to be deposited in the ash drawer. You will see the light color painted area on the cleaning rod to let you know the rod is in OPEN position (**Figure 16.3**).
  - c. Pull the firepot cleaning rod OUT and IN a couple of times to help shake debris loose. If the rod is hard to pull, it may be necessary to use your firepot clean-out tool to chip away material that has built up on the bottom plate of the firepot and to push out any clinkers while in the open position.
  - d. To close the firepot floor: slightly raise the cleaning rod and then push it back into place. If you have closed the cleaning rod properly (pushed all the way in) you will not see any of the light color painted area (**Figure 16.3**).
  - e. Always have the ash drawer in place before pulling the firepot cleaning rod, otherwise the ashes will fall down and fill the outside air opening and the appliance will produce soot out of the exhaust and will affect efficiency.



Firepot Cleaning Rod  
Figure 16.2

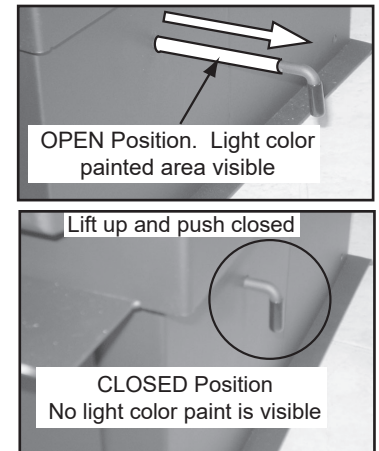

Figure 16.3

## ! WARNING



### Fire Risk

- NEVER pull firepot cleaning rod out when appliance is operating.
- Cleaning Rod MUST be completely pushed in before operating appliance.
- Hot pellets may fall into ash pan and start a fire or mis-starts due to lack of vacuum.

### 3. Ash Removal from Firebox

- **Frequency:** Weekly or more frequently depending on ash build-up.
- **By:** Homeowner
  - a. There must not be any hot ashes in the firebox during cleaning so allow the appliance to completely cool. The firebox ash should be removed every time the exhaust path is cleaned. Frequent cleaning of the ash in the firebox will help slow down the build-up of ash in the exhaust blower and vent system.
  - b. Vacuum out the firebox thoroughly on both sides of the firebox and the floor and ceiling. The ash drawer should be emptied every time you clean the firebox. Remember to place the ash and debris into a metal or non-combustible container. See Disposal of Ashes (Pg 17).
  - c. Always have the ash drawer in place before pulling the firepot cleaning rod, otherwise the ashes will fall down and fill the outside air opening and the appliance will produce soot out of the exhaust and will affect efficiency.

## ! WARNING



### Burn Risk

- NEVER remove ash drawer while appliance is operating.

#### 4. Cleaning Ash Drawer

- **Frequency:** Weekly or every 5 bags of fuel
- **By:** Homeowner
  - a. There must not be any hot ashes in the ash drawer when you empty it, so allow the appliance to completely cool.
  - b. Locate the ash drawer underneath the firepot. Slide the ash drawer straight out. Empty into a non-combustible container and re-install the ash drawer. See Disposal of Ashes (Pg 17).
  - c. Always have the ash drawer in place before pulling the firepot cleaning rod, otherwise the ashes will fall down and fill the outside air opening and the appliance will produce soot out of the exhaust and will affect efficiency.

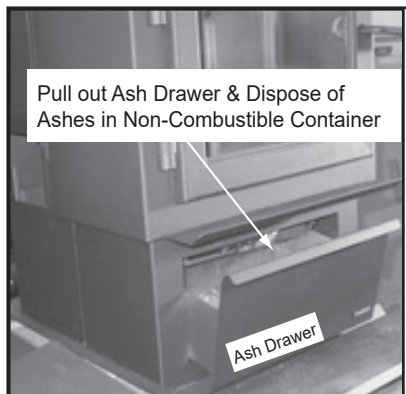

Figure 17.1

#### 5. Disposal of Ashes

- **Frequency:** As needed
- **By:** Homeowner

Ashes should be placed in a metal container with a tight-fitting lid. The closed container of ashes should be placed on a non-combustible floor or on the ground, well away from all combustible materials, pending final disposal.

If the ashes are disposed of by burial in soil or otherwise locally dispersed, they should be retained in the closed container until all cinders have been thoroughly cooled.



### WARNING

#### Disposal of Ashes



- Ashes should be placed in metal container with tight fitting lid.
- Ashes should be retained in closed container until all cinders have thoroughly cooled.

#### 6. Cleaning the Exhaust Path, Baffles & Drop Tube

- **Frequency:** Monthly or every 25 bags or more frequently depending on ash build-up.
- **By:** Homeowner
  - a. Appliance must be completely cool.
  - b. Open the door and remove the center baffle first and then the right and left baffles. See Baffle Removal Instructions on page 26. Thoroughly vacuum the exhaust path and drop tube and continue throughout the rest of the firebox. Also vacuum the front and back of the baffles.
  - c. Also vacuum the combustion blower impellers or use a soft brush to remove any ash build-up.

Replace the right and left baffles and then the center baffle and close and latch the door.

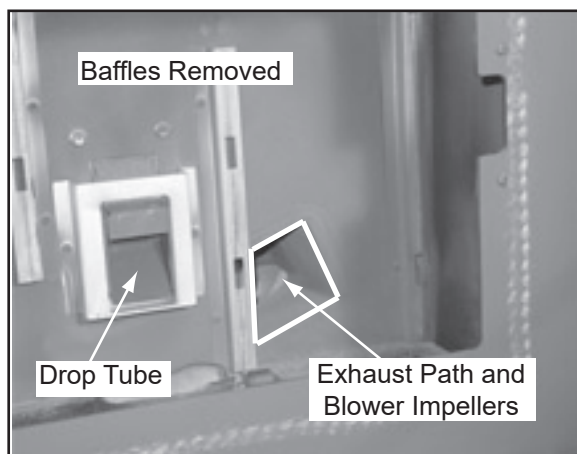

Figure 17.2

#### 7. Cleaning the Hopper

- **Frequency:** Monthly or after burning 50 bags of fuel
- **By:** Homeowner

After burning approximately 50 bags of fuel you will need to clean the hopper to prevent sawdust build-up.

A combination of sawdust and pellets on the bottom end of the auger reduces the amount of fuel supply to the firepot. This can result in nuisance shutdowns and mis-starts.

- a. The appliance must be in complete shutdown. Allow the appliance to completely run out of pellets and cool down.
- b. Empty the hopper of any remaining pellets.
- c. Vacuum the hopper and feed tube.

**NOTE:** Hearth & Home Technologies recommends to use a heavy duty vacuum cleaners specifically designed for solid fuel appliance cleaning.

## 8. Soot and Fly Ash: Formation & Need for Removal in Exhaust Venting System.

- **Frequency:** Yearly or more frequently depending on ash build-up.
- **By:** Qualified Service Technician/Homeowner  
Be sure the appliance is allowed to cool, has been unplugged and the exhaust blower is off.

The products of combustion will contain small particles of fly ash. The fly ash will collect in the exhaust venting system and restrict the flow of the flue gases.

At start-up if there is incomplete combustion, or if there is a shutdown or incorrect operation of the appliance it will lead to some soot formation. This will collect in the exhaust venting system.

The venting (chimney) system may need to be cleaned at least once a year or more often depending upon the quality of your fuel or if there are any horizontal pipe sections. Ash will build up more quickly in the horizontal sections and elbows.

## 9. Door Handle Inspection

- **Frequency:** Monthly or prior to heating season
- **By:** Homeowner

The gasket between the glass and firebox should be inspected periodically to make sure there is a good seal. Check door handle for smooth cam operation.

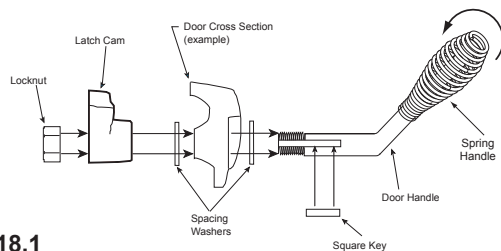

Figure 18.1

## 10. Cleaning the Glass

- **Frequency:** When clear view of the fire pot becomes obscure
- **By:** Homeowner
  - a. Appliance must be completely cool before cleaning glass.
  - b. Vacuum fly ash from glass and door rope.
  - c. Use a damp paper towel or any non-abrasive glass cleaner. Wipe off with dry towel.



### CAUTION

Handle glass assembly with care.

#### When cleaning glass:

- Avoid striking, scratching or slamming glass.
- Do NOT clean glass when hot.
- Do NOT use abrasive cleaners.
- Refer to maintenance instructions.

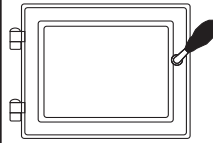

### WARNING

Handle glass with care.

- Inspect the gasket to ensure it is undamaged.
- Do NOT strike, slam or scratch glass.
- Do NOT operate appliance with glass assembly removed.

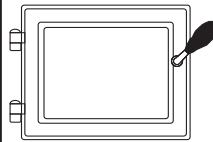

## 11. Cleaning Exhaust Blower - Requires No Lubrication

- **Frequency:** Yearly or more frequently depending on ash build-up
- **By:** Homeowner or Qualified Service Technician
  - a. Be sure the appliance is allowed to cool, has been unplugged and the exhaust blower is off.
  - b. Follow the directions for cleaning the exhaust path found on page 17.
  - c. If unable to thoroughly clean the blower through this access, then follow the directions on page 25 for direct access to the exhaust blower.
  - d. Vacuum the blower's impellers. Use care not to bend or damage the blower fins.

**NOTE:** Hearth & Home Technologies recommends to use a heavy duty vacuum cleaners specifically designed for solid fuel appliance cleaning.

## 12. Cleaning Convection Blower - Requires No Lubrication

- **Frequency:** Yearly or more frequently depending on Dust/Dirt build-up
- **By:** Homeowner or Qualified Service Technician
  - a. Be sure the appliance is allowed to cool and has been unplugged.
  - b. Follow the directions on page 24 for direct access to the convection blower.
  - c. Sweep or vacuum out any build-up. Use a brush or compressed air to loosen dirt if needed.

## 13. Cleaning the Top Vent Adapter

- **Frequency:** Yearly or more frequently depending on ash build-up
- **By:** Homeowner
  - a. The appliance must be in complete shutdown and the exhaust blower should be off. Allow the appliance to completely cool down.
  - b. Open the clean-out cover (**Figure 19.1**).
  - c. Sweep or vacuum out any ash build-up.

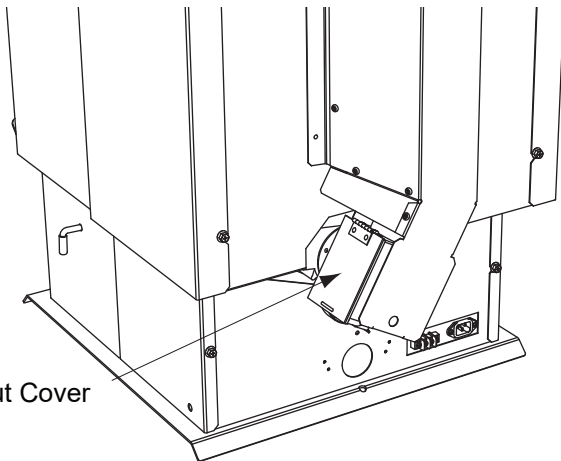

Figure 19.1

## 14. Preparing Firebox for Non-Burn Season

- **Frequency:** Yearly
- **By:** Homeowner
  - a. Be sure the appliance is allowed to cool, has been unplugged and the exhaust blower is off.
  - b. Remove all ash from the firebox and vacuum thoroughly.
  - c. Paint all exposed steel, including cast-iron.
    - Purchase paint from your local dealer.
    - Must use a high-temperature paint made specifically for heating appliances.

### D. High Ash Fuel Content Maintenance

- **Frequency:** As needed
- **By:** Homeowner

Poor quality pellet fuel, or lack of maintenance, can create conditions that make the firepot fill quickly with ashes and clinkers.

This condition makes the appliance susceptible to overfilling the firepot with pellets which may result in smoking, sooting and possible hopper fires. **Figure 20.1** shows an example where the firepot overfills, pellets back up into the feed tube and ash has accumulated in the firebox.

An inefficient and non-economical method of burning of fuel caused by poor quality pellet fuel is shown in **Figure 20.2**.

The correct flame size when good quality, premium pellet fuel is burned is shown in **Figure 20.3**.

If the ash buildup exceeds the half way point in the firepot IMMEDIATE ATTENTION AND CLEANING IS REQUIRED.

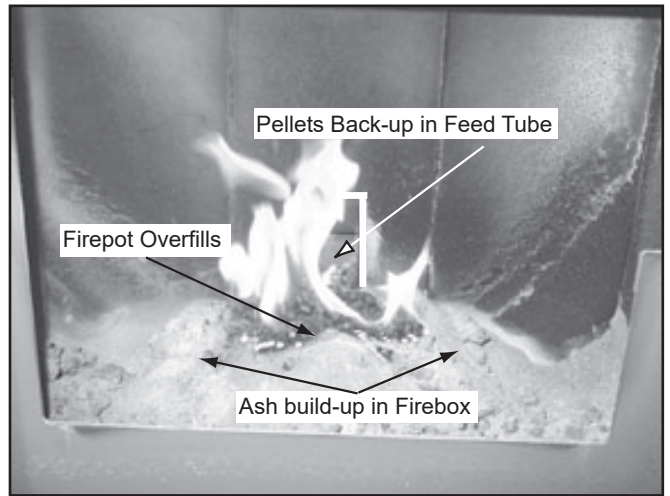



Figure 20.1

 <b>WARNING</b>	
	<b>Fire Risk</b>
	<ul style="list-style-type: none"> <li>• High ash fuels, or lack of maintenance, can cause the firepot to overfill. Follow proper shutdown procedure if ash buildup exceeds halfway point in firepot.</li> <li>• Failure to do could result in smoking, sooting and possible hopper fires.</li> </ul>

### E. Soot or Creosote Fire

Establish a routine for the fuel, wood burner and firing technique. Check daily for creosote build-up until experience shows how often you need to clean to be safe. Be aware that the hotter the fire the less creosote is deposited, and weekly cleaning may be necessary in the mild weather even though monthly cleaning may be enough in the coldest months. Contact your local municipal or provincial fire authority for information on how to handle a chimney fire.

**In the event of a soot or creosote fire, close the firebox door, exit the building immediately and contact the proper fire authorities.**

**DO NOT under any circumstances re-enter the building.**

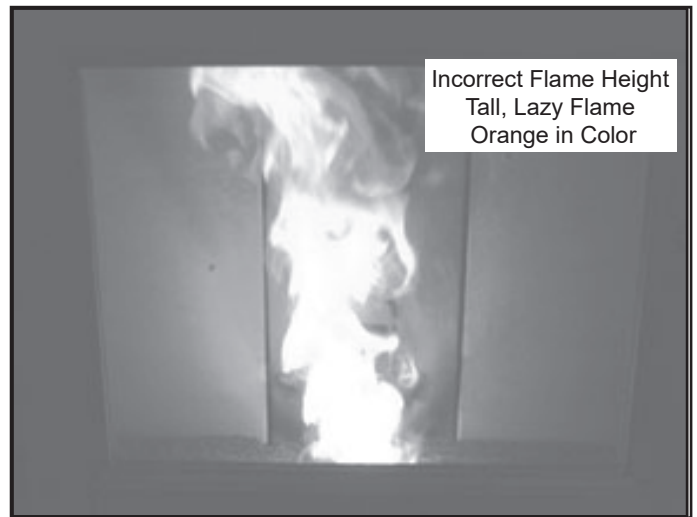

Figure 20.2

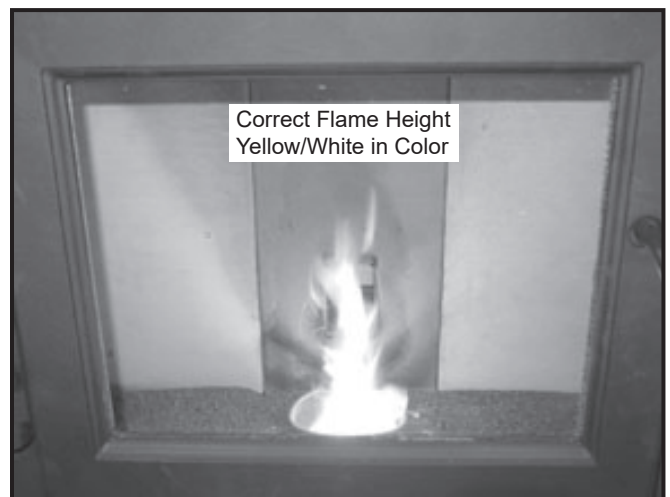

Figure 20.3



# 4 Troubleshooting Guide

With proper installation, operation, and maintenance your appliance will provide years of trouble-free service. If you do experience a problem, this troubleshooting guide will assist a qualified service person in the diagnosis of a problem and the corrective action to be taken. This troubleshooting guide can only be used by a qualified service technician.

Symptom	Possible Cause	Corrective Action
Plug in appliance - No response.	No current to outlet. 7 amp fuse defective. #3 snap disc tripped or defective. Control box defective.	Check circuit breaker at service panel. Replace fuse. Reset or replace snap disc. Replace control box.
Call light on. No fire. No fuel in fire pot.	Out of fuel. #2 snap disc may be defective. Vacuum switch not closing, no vacuum.  Control box defective.	Check hopper. Fill with fuel. Replace snap disc. Check exhaust blower is plugged in and operating. Check vacuum switch is plugged in. Check vacuum hose is in good condition, clear and connected at both ends. Check thermocouple is in good condition and plugged in properly. Make sure venting system is clean. Make sure front door is closed. Replace control box.
Call light on. No fire. Partially burned fuel in fire pot.	Fire pot clean-out plate not closed. Fire pot is dirty (missed ignition).	Check that fire pot clean-out plate is fully closed. Clean fire pot. Make sure there is no clinker in the fire pot. Clinkers may have to be broken up with fire pot scraper tool or other means.
Call light on. No fire. Unburned pellets in fire pot.	Fire pot clean-out plate not closed. Fire pot is dirty.  Ignition hole blocked. Igniter not working.  Control box defective.	Check that fire pot clean-out plate is fully closed. Clean fire pot. Make sure there is not a clinker in the fire pot. Clinkers may have to be pushed out of fire pot with fire pot scraper tool or other means. Scrape with solid piece of wire. Remove ash pan to see if igniter is glowing red on start-up. Check igniter wires for good connection. Replace igniter using 1/4 inch male /female spade connectors. Replace control box.
Slow or smoky start-up.	Fire pot clean-out plate not closed. Fire pot is dirty.  Excessive amount of fuel at start-up.	Check that fire pot clean-out is fully closed. Clean fire pot. Make sure there is not a clinker in the fire pot. Clinkers may have to be pushed out of fire pot with fire pot scraper tool or other means. Reduce feed rate using feed rate adjustment control rod located inside hopper.

Symptom	Possible Cause	Corrective Action
Slow or smoky start-up (Cont'd)	Dirty exhaust and/or venting system.	Check for ash build up in appliance, including behind rear panels, firebox, heat exchanger, exhaust blower and venting.
Feed system fails to start.	Out of fuel. #2 snap disc may be defective.  Vacuum switch not closing. No vacuum.  Feed system jammed or blocked.  Feed spring not turning with feed motor.  Feed motor defective or not plugged in.	Check hopper, fill with fuel. Replace snap disc. Firebox door must be closed securely.  Check exhaust blower is plugged in and operating. Check vacuum switch is plugged in. Check vacuum hose is in good condition, clear and connected at both ends. Check thermocouple is in good condition and plugged in properly. Make sure venting system is clean. <b>NOTE:</b> High winds blowing into the venting system can pressurize the firebox causing loss of vacuum. Empty hopper of fuel. Use a wet/dry vacuum cleaner to remove remaining fuel, from hopper, including feed tube. Check feed chute for obstructions. Loosen 2 screws and jiggle feed assembly. Check that set screw is tight on feed spring shaft at end of feed motor. Check connections on feed motor, replace if defective.
No call light. Appliance does not begin start sequence.	Thermostat not set to a high enough temperature. Snap Disc #3 tripped. No power. Fuse blown. Connections at thermostat and/or appliance not making proper contact. Defective thermostat or thermostat wiring.  Control box defective.	Adjust thermostat above room temperature. Reset snap disc. Connect to power. Replace fuse. Check connections at thermostat and appliance. Replace thermostat or wiring. <b>NOTE:</b> To test thermostat and wiring, use a jumper wire at the thermostat block on the appliance to by-pass thermostat and wiring.  Replace control box.
Appliance fails to shut off.	Call light on.	Turn thermostat off. If call light does not go out, disconnect thermostat wires from appliance. If call light does go out, thermostat or wires are defective.

Symptom	Possible Cause	Corrective Action
Convection blower fails to start.	No call light. #1 snap disc defective. Blower not plugged in. Blower is defective. Control box is defective.	Defective control box. Replace snap disc. Check that blower is plugged into wire harness. Replace blower. Replace control box.
Exhaust blower fails to start or does not shut off.	Blower not plugged in. Blower is clogged with ash. Blower is defective. Control box is defective.	Check that blower is plugged into wire harness. Clean exhaust system. Replace blower. Replace control box.
Large, lazy flame, orange color. Black ash on glass.	Dirty appliance. Poor fuel quality, high ash content. Fire pot clean-out plate not completely closed. Excessive amount of fuel.	Clean appliance, including fire pot, heat exchangers and venting system. Remove stainless steel baffle from firebox to clean ash from on top of baffle. Clean behind rear brick panels. Change fuel brand to premium. Check that fire pot clean-out plate is fully closed. Reduce feed rate using feed rate adjustment control rod located inside hopper.
Nuisance shutdowns.	Low flame. Sawdust buildup in hopper. Feed motor is reversing. Defective thermocouple. Defective control box. Fire pot more than 1/2 full	Increase feed by opening feed rate adjustment control rod located inside hopper. Clean hopper, see <b>page 35</b> . Check for good connections between feed motor and wire harness. Replace thermocouple. Replace control box. See <b>page 38</b> for detailed instructions for "High Ash Fuel Content Maintenance".
Appliance calls for heat. Call light illuminates. Exhaust blower starts. No feed or igniter.	Thermocouple is defective or not properly plugged in. Defective control box	Check connections on thermocouple or replace if defective. A flashing yellow light on the control box indicates a problem with the thermocouple. Replace control box.

# 5 Service Parts Replacement

## A. Convection Blower Replacement

1. Turn down the thermostat, let appliance completely cool and then unplug appliance before servicing.
2. The convection blower is located on the floor at the rear of the appliance.
3. Lift the hopper lid up until it locks into place.
4. Loosen the 4 screws on the upper back panel and the 2 screws on the lower back panel, using a #2 Phillip Head screwdriver, a 3/8 inch wrench or a 3/8 Inch socket. You do not need to remove them (**Figure 24.1**).
5. Remove the left upper and lower side panels by lifting up and out. The hooks on the panels will slide out of the slots on the appliance (**Figure 24.2**).
6. Release blower wires from the nylon wire retainer if applicable. Your PS35 has 2 black wires.
7. Remove the wing bolt and move the blower and hold-down bracket toward the back of the appliance to release the locating tab (**Figure 24.3**). Pull the blower out from under the convection plenum. Slide the blower out of the appliance. Disconnect the wires from the spade connectors at this time (**Figure 24.4**).
8. Return wires to nylon wire retainer. Make sure wires do not contact any moving parts or touch any surfaces that may become hot (**Figure 24.4**).

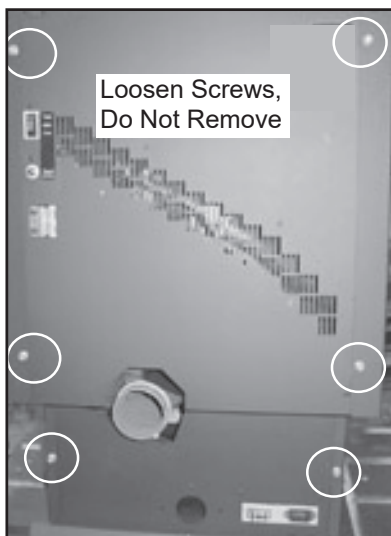

Figure 24.1

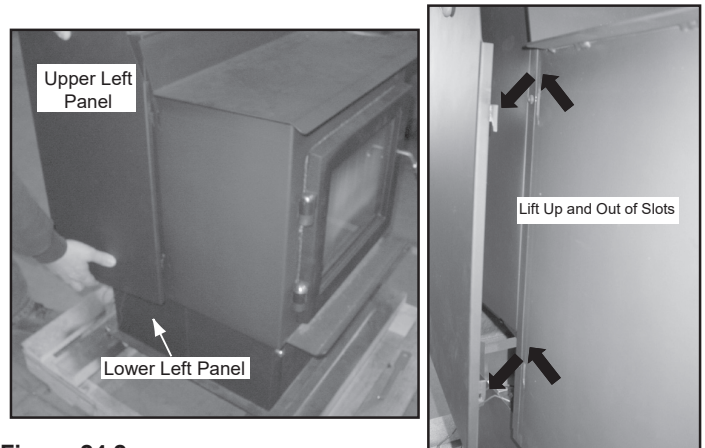

Figure 24.2

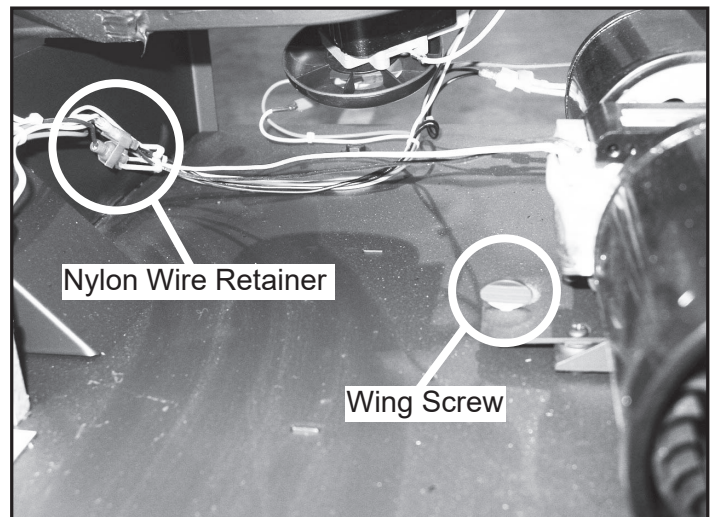

Figure 24.3

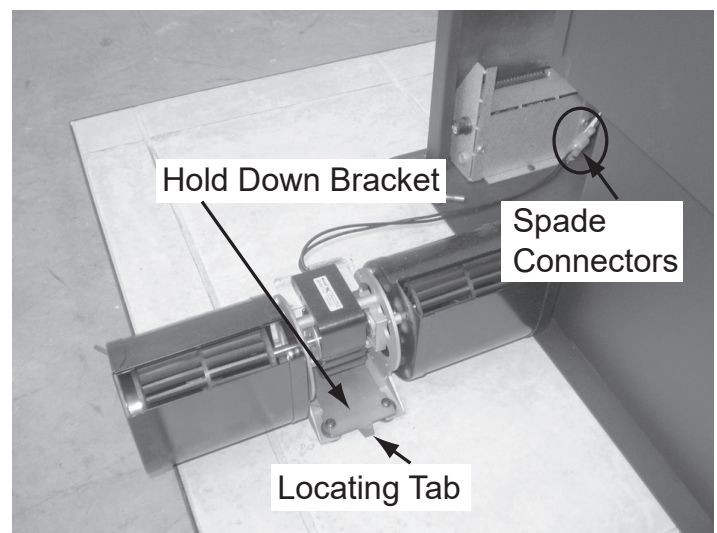

Figure 24.4

## B. Exhaust Blower Replacement

1. Turn down the thermostat, let appliance completely cool and then unplug appliance before servicing.
2. Remove both upper and lower right side curtains (**Figure 24.2 on page 24**).
3. Disconnect 2 white wires from the white and blue wires of the exhaust blower.
4. There is a removable plate on the exhaust blower. Depending on the model, use a 1/4 inch socket, or 1/4 inch Nut Driver or #2 Phillips Head screw driver to loosen the 6 screws in the keyhole shaped holes and rotate the plate. It is only necessary to loosen screws (**Figure 25.1**).
5. Remove the exhaust blower and gasket.
6. Check for degradation on the gasket and replace if necessary using the gasket included in the kit.
7. Re-install in reverse order.

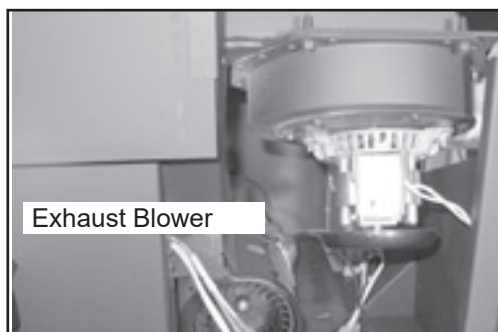

Figure 25.1

## C. Snap Disc Replacements

### Snap Disc #1 - Convection Blower

1. Turn down thermostat, let appliance cool completely if running. Then unplug appliance before servicing.
2. Using #2 Phillips screwdriver, 3/8" wrench, or 3/8" socket loosen the three screws that hold the right upper and lower side panels in place. You do not need to remove the screws. Remove side panels by lifting up and out.
3. Snap disc #1 is located on the convection plenum below the feed motor (**Figure 25.2**).
4. It has two purple wires attached to it with 1/4 inch female spade terminals.
5. Disconnect the two wires from the snap disc. Using a #2 Phillips screwdriver, remove the two screws securing the snap disc to the appliance.
6. Re-install in reverse.

### Snap Disc #2 - Fuel Delivery Interrupt

1. Turn down thermostat, let appliance cool completely if running. Then unplug appliance before servicing.
2. Using #2 Phillips screwdriver, 3/8" wrench, or 3/8" socket loosen the three screws that hold the right upper and lower side panels in place. You do not need to remove the screws. Remove side panels by lifting up and out.
3. Snap disc #2 is located on the convection plenum in the center of the appliance above the convection blower (**Figure 25.2**).
4. It has a black wire and an orange wire attached to it with 1/4 inch female spade terminals.
5. Disconnect the two wires from the snap disc. Using a #2 Phillips screwdriver, remove the two screws securing the snap disc to the appliance.
6. Re-install in reverse.

### Snap Disc #3 - Feed Motor - Manual Reset

1. Turn down thermostat, let appliance cool completely if running. Then unplug appliance before servicing.
2. Using #2 Phillips screwdriver, 3/8" wrench, or 3/8" socket loosen the three screws that hold the right upper and lower side panels in place. You do not need to remove the screws. Remove side panels by lifting up and out.
3. Snap disc #3 is located on the bracket on the feed tube near the feed motor (**Figure 25.2**).
4. It has two gray wires attached to it with 1/4 inch female spade terminals.
5. The locating bracket is attached to the feed tube with an 8 X 32 wing nut. Remove the wing nut to detach the bracket from the feed tube.
6. Disconnect the two wires from the snap disc.
7. Using a #2 Phillips screwdriver, remove the screw securing the snap disc to the bracket (**Figure 25.3**).
8. Re-install in reverse.

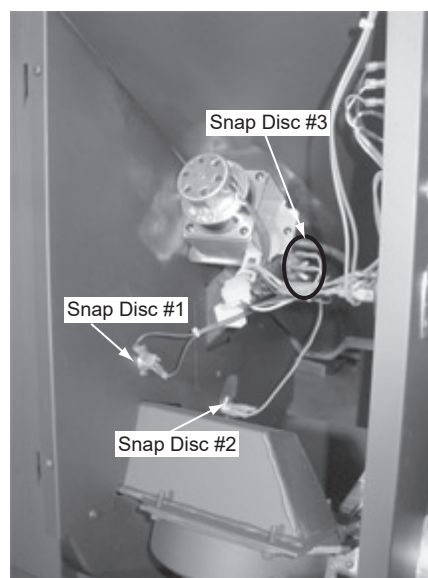

Figure 25.2

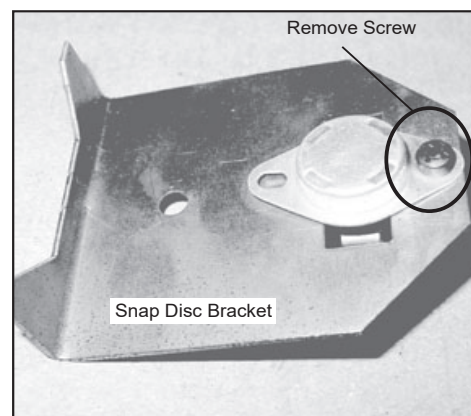

Figure 25.3

### D. Igniter Replacement

1. Shut down the appliance by turning down the thermostat and let the appliance completely cool down. After the appliance has cooled down, unplug it and remove the ash drawer.
2. The wire leads to the igniter are connected to the wire harness with 1/4 inch male / female spade connectors.
3. Follow the directions on page 21 to remove the upper and lower right side panels to expose the spade connectors.
4. Disconnect the spade connectors and remove the igniter from the chamber. Loosen thumb screw and slide igniter out.
5. Install new igniter into the chamber and tighten thumb screw. The wires MUST route through the wire retainer hook and then re-connect the wires to the 2 leads with the spade connectors **(Figure 26.1)**.
6. Double check that the igniter wires are clear of any movement, i.e. ash drawer, firepot cleaning rod, etc.
7. Re-install the ash drawer and side panel and re-connect the power.

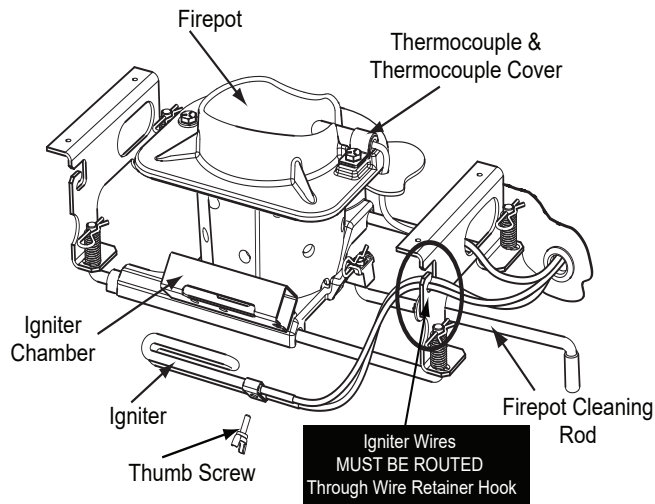

Figure 26.1

### E. Baffle Removal & Replace

1. Shut down the appliance by turning down the thermostat and let the appliance completely cool down.
2. Remove the center baffle first by using the handle at the top of the baffle and pull up and then towards you. The hooks on the baffle will slide out of the slots in the bracket **(Figure 26.2)**.
3. Remove the left baffle and then the right baffle by pulling up and then towards you. The left and right baffles have similar hooks and slots **(Figures 26.3 and 26.4)**.
4. Re-install the baffles in reverse order. Be careful to insert the hooks in their respective slots. Be sure the baffles are completely secure/seated (close, if not touching, the firebox floor).

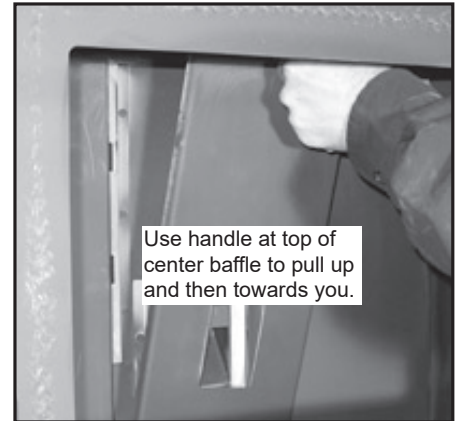

Figure 26.2

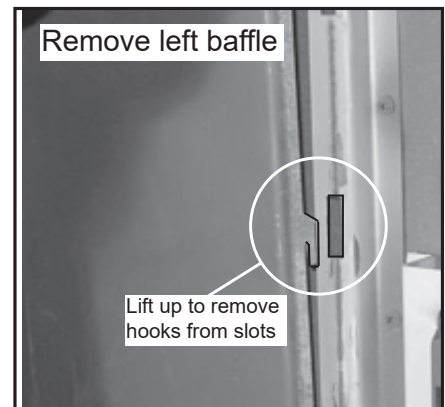

Figure 26.3

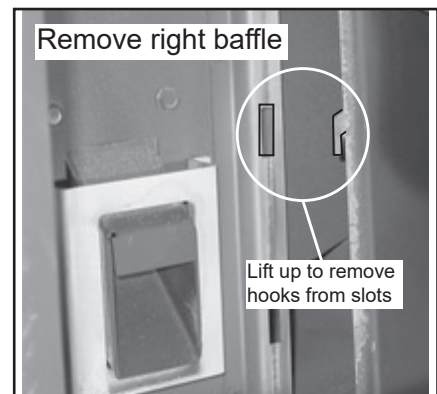

Figure 26.4

## F. Glass Replacement

1. Open the door from the appliance by lifting door off of hinge pins and lay on a flat surface face down.
2. Using a Phillips Head screw driver, remove the 4 brackets and set aside (**Figure 27.1**).
3. Remove old glass and replace with the new glass.
4. Re-install the brackets using the same screws.

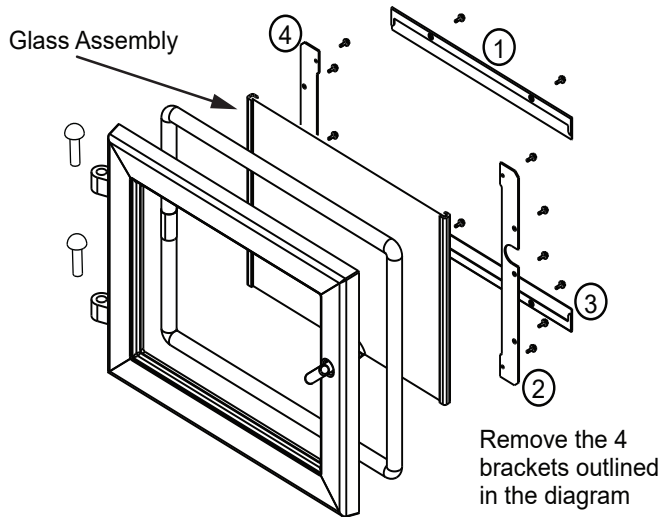

Figure 27.1



### WARNING



- Glass is 5mm thick high temperature heat-resistant ceramic glass.
- DO NOT REPLACE with any other material.
- Alternate material may shatter and cause injury.

# 6 Reference Materials

## A. Component Functions

### 1. Control Box

- The control box is located on the lower left side of the appliance, behind the lower left side panel and above the junction box.
- There is a light located inside of the control box. The internal light will turn green when the appliance has reached a temperature of 200°F (93°C) in the fire pot. and will turn red when it reaches 600°F (315°C).
- There is also an internal blue light located in the control box. When you plug in the appliance the blue light will automatically start blinking. For model PS35 the blue light should flash 7 times every 10 seconds for the first 60 seconds after power up. For models PS50 and CAB50 it should blink 2 times.

#### To set your control board on the correct number:

- Unplug the appliance.
- Using #2 Phillips screw driver, 3/8" wrench, or 3/8" socket loosen the three screws that hold the right upper and lower side panels in place. You do not need to remove the screws. Remove side panels by lifting up and out.
- Use a #2 Phillips screw driver to remove the control box retainer bracket and lift control box out of the junction box.
- Using a 1/4 inch flat head screw driver turn the rotary switch until the desired number is showing on the dial.
- Re install control box and plug in appliance.
- To confirm your selection is correct count the number of times the blue light flashes.

**Example:** If you are on setting 2 the control box will flash 2 times every 10 seconds for 1 minute.

Your PS35 is set to #7 (7 flashes) (**Figure 28.1**).

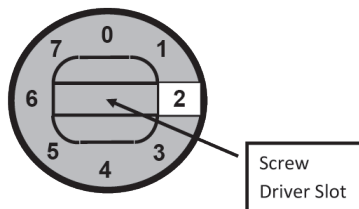

Figure 28.1 - Rotary Switch

**NOTE:** Do NOT open the control box. This will void the warranty. If you need to plug in or remove the control box you must first unplug the appliance.

**When describing the location of a component, it is always AS YOU FACE THE FRONT OF THE APPLIANCE.**

### 2. Convection Blower

The convection blower is mounted at the bottom rear of the appliance. There are 2 impellers, one on each side of the motor. The convection blower pushes heated air through the heat exchange system into the room.

### 3. Exhaust Blower

The exhaust blower is mounted on the right side of the appliance. The exhaust blower is designed to pull the exhaust from the appliance and push it out through the venting system.

### 4. Feed System

The feed system is located on the right side of the appliance and can be removed as an entire assembly. The assembly includes the feed motor, mounting bracket, bearing and feed spring (auger). The hollow feed spring (auger) pulls pellets up the feed tube from the hopper area and drops them down the feed chute into the fire pot.

### 5. Fire pot

The fire pot is made of high quality ductile iron and has a cleaning pull-out rod. The floor of the fire pot opens for cleaning when you pull out the rod. Be sure that the floor returns to a completely closed position or your appliance will not operate properly.

### 6. Fuse

The fuse is located on the side of the junction box above to the red call light. The fuse will blow should a short occur and shut off power to the appliance.

### 7. Heat Output Switch

The heat output switch is located on the upper right back panel. The function of the heat output switch is to regulate the burn rates; low, medium and high settings.

### 8. Hopper Switch

The hopper switch is located in the upper right hand corner of the hopper. This switch is designed to shut down the feed motor whenever the hopper lid is opened.

### 9. Igniter

The igniter is mounted on the base of the fire pot. Combustion air travels over the red hot igniter creating super heated air that ignites the pellets.

### 10. Junction Box And Wiring Harness

The junction box is located on the lower left side of the appliance, behind the left side panel. The junction box and wiring harness are replaced as one component.



**11. Power Supply**

The power outlet is located behind the control box on the back of the appliance, lower left corner. Check the wall receptacle for 120 volt, 60 Hz (standard current). Make sure the outlet is grounded and has the correct polarity. A good surge protector is recommended.

**12. Red Call Light**

The red call light is on the side of the junction box, below the fuse. The function of the red call light is to indicate that the thermostat is calling for heat.

**13. Reset Button**

The reset button is located on the back of the appliance in the upper right corner below the heat output control switch. The function of the button is to momentarily open the thermostat circuit, which restarts the system.

**14. Thermocouple**

The thermocouple is located on top of the firepot inside the thermocouple cover (ceramic protection tube). The thermocouple sends a millivolt signal to the control box indicating the preset temperatures of the green and red lights have been obtained.

**15. Thermostat**

The appliance is designed to run on a 12 volt AC thermostat. The heat anticipator should be set on the lowest setting available.

**16. Snap Disc #1 (Convection Blower) 110°F**

Snap disc #1 is located on the right side of the appliance behind the right side panel. There are 2 purple wires connected to it. This snap disc turns the convection blower on and off as needed. Power is always present at snap disc #1.

**17. Snap Disc #2 (Fuel Delivery Interrupt) 175°F**

Snap disc #2 is located on the center of the convection plenum above the convection blower. There is an orange and a black wire connected to it. This snap disc will turn off the feed system which will turn off the appliance if an over fire condition should occur or if the convection blower should fail to operate. If this occurs you will have to manually reset the snap disc.

**18. Snap Disc #3 (Back Burn Protector) 250°F**

Snap disc #3 is mounted on the back of the auger tube in the center of the appliance and has a reset button. There are two gray wires connected to it. To access it remove the right side panel. If the fire tries to burn back into the feed system or push exhaust up the feed tube, this snap disc will shut the entire system off. This disc must be manually reset.

**19. Vacuum Switch**

The vacuum switch is located on the lower right side of the appliance behind right side panel. There are two red wires attached to it. This switch turns the feed system on when vacuum is present in the firebox. The vacuum switch is a safety device to shut off the feed motor if the exhaust or the heat exchanger system is dirty or plugged or if the firebox door is open.

**20. Wiring Harness**

See **Figure 29.1** below.

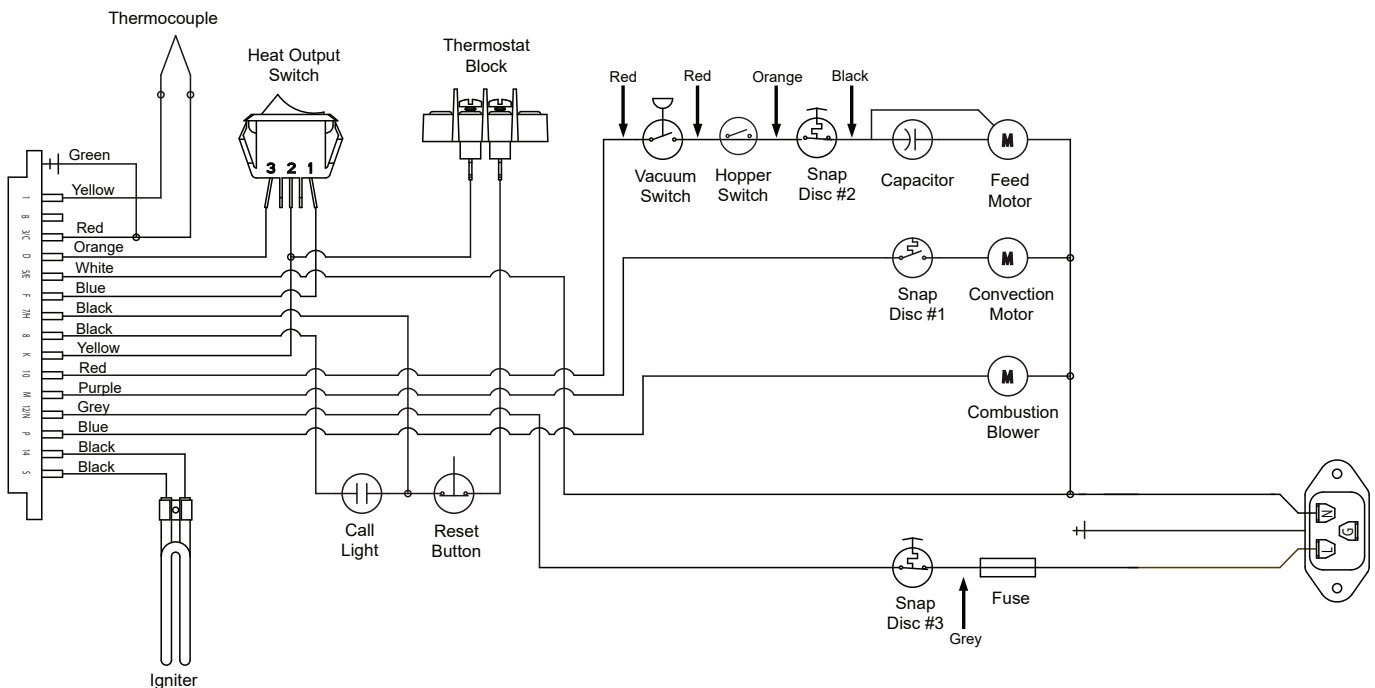

**Figure 29.1**

## B. Component Locations

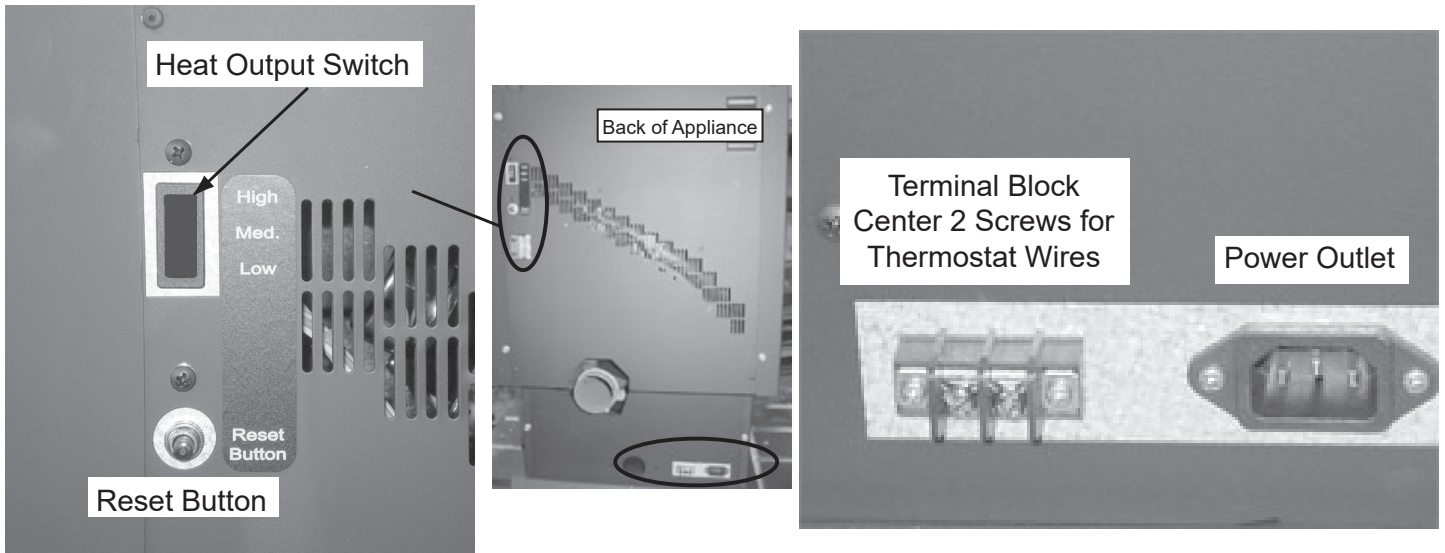

Figure 30.1

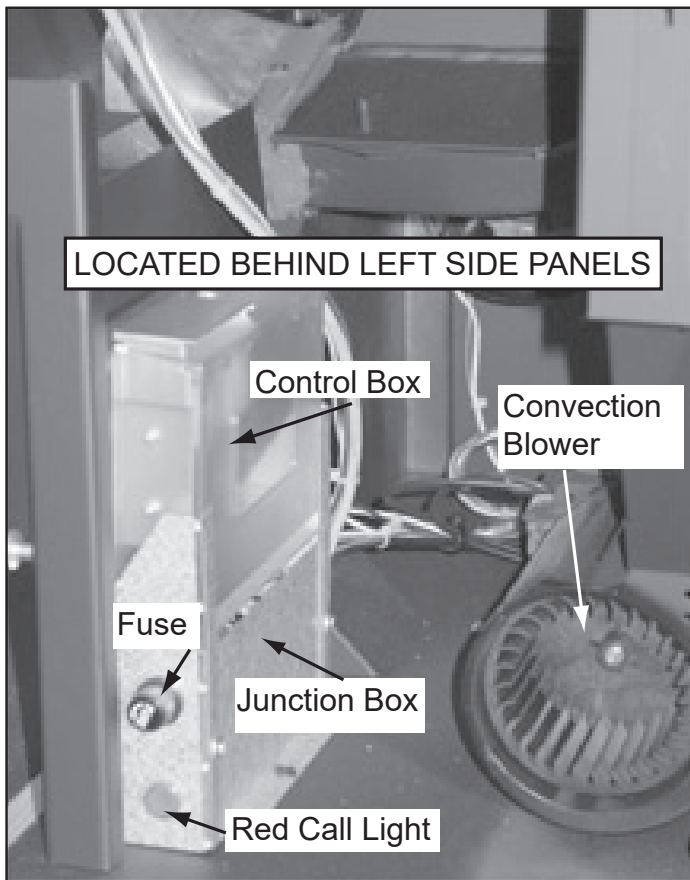

Figure 30.2

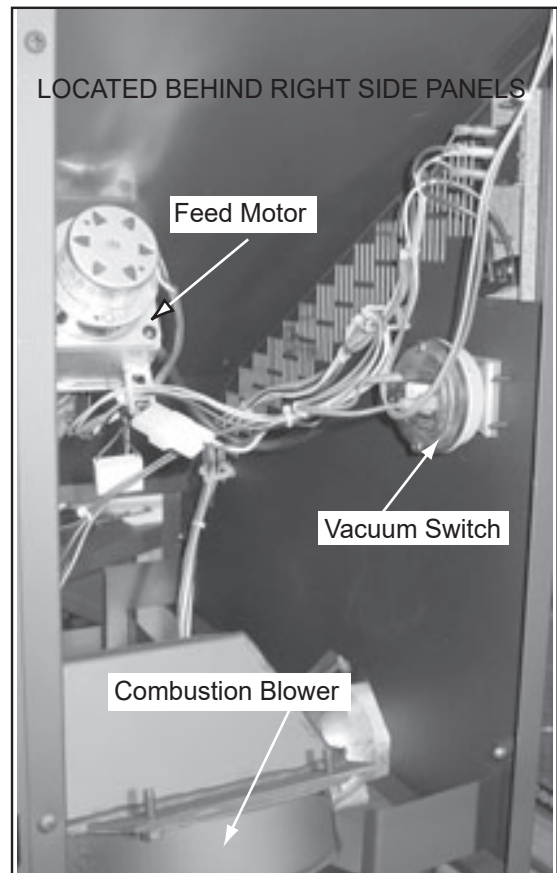

Figure 30.3









D. Exploded Drawing



Service Parts  
Free Standing Pellet Stove

PS35-C

Beginning Manufacturing Date: May 2019  
Ending Manufacturing Date: Active

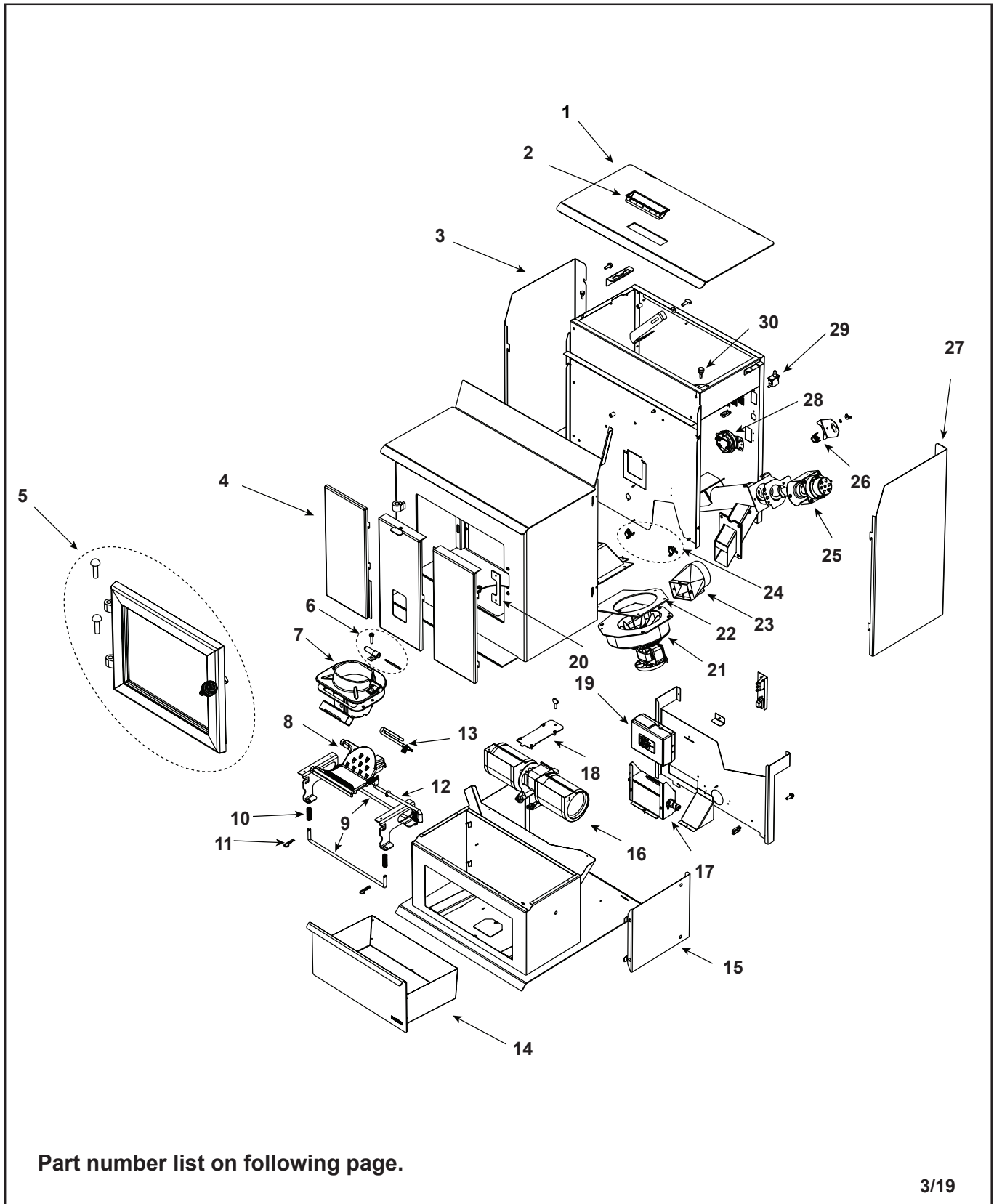

E. Service Parts



Service Parts

PS35-C

Beginning Manufacturing Date: May 2019  
Ending Manufacturing Date: Active



IMPORTANT: THIS IS DATED INFORMATION. Parts must be ordered from a dealer or distributor. **Hearth and Home Technologies does not sell directly to consumers.** Provide model number and serial number when requesting service parts from your dealer or distributor.

Stocked at Depot

Item	Description	Comments	Part Number	Stocked at Depot
1	Hopper Lid Assembly		SRV7058-009	
2	Handle, Hopper Lid		SRV200-0110	
3	Side Curtain, Left		SRV7058-125	
4	Baffle Assembly		SRV7058-026	Y

#5 Door Assembly

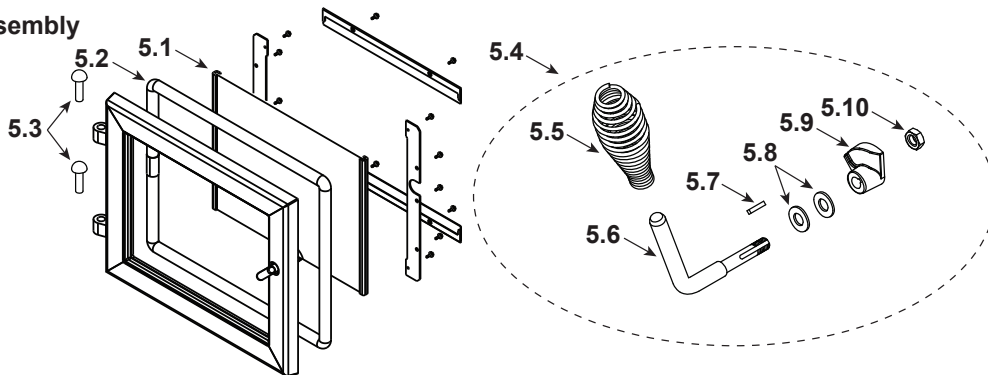

5	Door Assembly		SRV7058-014	
5.1	Glass Assembly		SRV7058-015	Y
5.2	Rope, Door, 3/4" X 84"		832-1680	Y
	Corner Tape	1 Ft	SRV560-437-9	
	Gasket, Glass Tape, 3/4" X 1/8"	5 Ft	832-0460	Y
5.3	Hinge Pin, 1/2"	Nickel	SRV430-5320	
5.4	Door Handle Assembly		SRV7058-030	Y
5.5	Spring Handle, 1/2"	Black	250-8330	Y
5.6	Handle, Formed Door		SRV7058-182	
5.7	Key Latch, Cam		SRV430-1151	
5.8	Washer, SAE, 3/8 (Qty 2 req)	Pkg of 3	832-0990	Y
5.9	Cam Latch		SRV430-1141	
5.10	Nut, 2-Way Side-Lock Jam	Pkg of 24	226-0100/24	Y

#6 Thermocouple Assembly

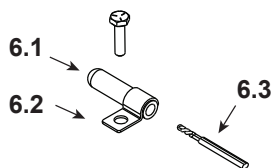

6.1	Thermocouple Protection Tube		SRV7034-186	Y
		Pkg of 10	SRV7034-186/10	
6.2	Half Clip		7000-321	
6.3	Thermocouple		812-4470	Y

Additional service parts on following page





## Service Parts



PS35-C

Beginning Manufacturing Date: May 2019

Ending Manufacturing Date: Active

IMPORTANT: THIS IS DATED INFORMATION. Parts must be ordered from a dealer or distributor. **Hearth and Home Technologies does not sell directly to consumers.** Provide model number and serial number when requesting service parts from your dealer or distributor.

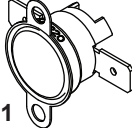
**Stocked  
at Depot**

Item	Description	Comments	Part Number	Stocked at Depot
7	Firepot Assembly		SRV7034-072B	Y
	Gasket, Firepot		SRV7034-190	Y
8	Firepot Bottom		SRV7034-153	Y
9	Rail, Auto-Clean		SRV7034-152	Y
10	Spring	Pkg of 4	7000-513/4	Y
11	Hitch Pin Clip 3/32	Pkg of 10	7000-374/10	Y
12	Pull Rod		SRV7058-141	
13	Heating Element Assembly 18" (Loop Igniter)	Pkg of 1	SRV7000-462	Y
		Pkg of 10	SRV7000-462/10	Y
14	Ash Pan Assembly		SRV7058-013	
	Heatilator Logo		4021-049	
15	Pedestal Side	Qty 2 req	SRV7058-153	
16	Blower, Convection		812-4900	Y
17	Wire Harness		SRV7058-150	Y
	Fuse, 7 Amp, Junction Box	Pkg of 10	812-0380/10	Y
	Reset Button Assembly		SRV7000-040	
18	Blower Retainer		SRV7058-148	
19	Control Board 3 Speed Eco-Choice		SRV7058-188	Y
20	Latch Backing Plate		SRV7058-155	
21	Blower, Exhaust Combustion		812-4400	Y
22	Gasket, Exhaust Combustion Blower		SRV240-0812	Y
	Gasket, Combustion Blower, Round		812-4710	Y
23	Casting, Exhaust Transition		180-0190	
<p><b>Snap Disc's</b></p> <div style="display: flex; justify-content: space-around; align-items: center;"> <div style="text-align: center;">   <b>24.1</b>  <b>F110F-20</b> </div> <div style="text-align: center;">   <b>24.2</b>  <b>L250F Manual Reset</b> </div> <div style="text-align: center;">   <b>26</b>  <b>L175F Manual Reset</b> </div> </div>				
24	Snap discs			
24.1	Snap Disc, 110-20 ( #1 )	Right	SRV230-1220	Y
24.2	Snap Disc Manual Reset ( #2 )	Left	SRV230-1960	Y
25	Feed Assembly		SRV7058-007	Y
	Feed Bearing		SRV7000-598	Y
	Feed Motor		812-4421	Y
	Feed Spring Assembly (Only)		SRV7001-046	Y
	Gasket, Feed Motor		SRV7034-144	
26	Snap Disc ( #3 )		SRV230-1290	Y

Additional service parts on following page.







**CONTACT INFORMATION**

Hearth & Home Technologies  
352 Mountain House Road  
Halifax, PA 17032  
Division of HNI INDUSTRIES

**Please contact your Heatilator dealer with any questions or concerns.  
For the number of your nearest Heatilator dealer  
log onto [www.heatilator.com](http://www.heatilator.com)**

**CAUTION**



**DO NOT DISCARD THIS MANUAL**

Important operating and maintenance instructions included.

• Read, understand and follow these instructions for safe installation and operation.

• Leave this manual with party responsible for use and operation.



**We recommend that you record the following pertinent information for your heating appliance.**

Date purchased/installed: \_\_\_\_\_

Serial Number: \_\_\_\_\_ Location on appliance: \_\_\_\_\_

Dealership purchased from: \_\_\_\_\_ Dealer phone: 1(\_\_\_\_) \_\_\_\_\_ - \_\_\_\_\_

Notes: \_\_\_\_\_

\_\_\_\_\_

\_\_\_\_\_

This product may be covered by one or more of the following patents: (United States) 5341794, 5263471, 6688302, 7216645, 7047962 or other U.S. and foreign patents pending.

